

abox2

Wireless radiator thermostat

ART-200

Firmware version 1.00

EN

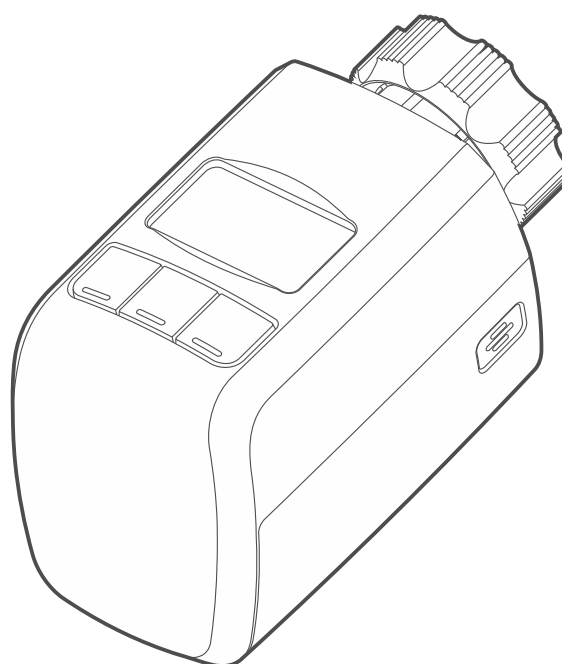

CE

art-200_en 12/22

Satel  [®]

SATEL sp. z o.o. • ul. Budowlanych 66 • 80-298 Gdańsk • POLAND
tel. +48 58 320 94 00
www.satel.pl

IMPORTANT

The device should be installed by qualified personnel.

Prior to installation, please read carefully this manual.

Changes, modifications or repairs not authorized by the manufacturer shall void your rights under the warranty.

The rating plate of the device is located on the enclosure base.

 The device meets the requirements of the applicable EU directives.



The device is designed for indoor installation.



The device must not be disposed of with other municipal waste. It should be disposed of in accordance with the existing rules for environment protection (the device was placed on the market after 13 August 2005).

 The device meets the technical regulations of the Eurasian Customs Union.

SATEL aims to continually improve the quality of its products, which may result in changes in their technical specifications and software. Current information about the changes being introduced is available on our website.

Please visit us:

<https://support.satel.pl>

Hereby, SATEL sp. z o.o. declares that the radio equipment type ART-200 is in compliance with Directive 2014/53/EU. The full text of the EU declaration of conformity is available at the following internet address: www.satel.pl/ce

The following symbols may be used in this manual:



- note,



- caution.

CONTENTS

1	Features	2
2	Description.....	2
	LCD display	3
	Keys	4
	Radio communication.....	5
	Energy saving mode (ECO)	5
	Battery status control.....	5
	Operating modes.....	5
	Thermostat calibration.....	5
	Thermostat adaptation	5
	Fast heating function (Boost Heat)	6
	Anti-scale protection.....	6
	Open window detection	6
	Anti-freeze protection	6
	Temperature measurement correction	6
	Child lock.....	6
3	Installation	6
	3.1 Installation on M30x1.5 mm valve	8
	3.2 Installation on Danfoss RA valve.....	8
4	Configuring the thermostat	10
	4.1 Remote configuration	10
	4.2 Configuration using the keys	10
	Enter the operating mode menu.....	10
	Change the operating mode.....	10
	Edit the operating mode settings	10
	Exit the operating mode menu	11
	Enter the advanced settings menu	11
	Edit the advanced settings	11
	Exit the advanced settings menu.....	12
5	Start the Boost Heat function.....	12
6	Thermostat status overview.....	12
7	Disabling the keys	13
8	Specifications	13

The ART-200 radiator thermostat is used to control the room temperature in a more energy-efficient way. The thermostat allows you to control the radiator valve remotely and manually. It is designed to work within the ABAX 2 two-way wireless system. It is supported by:

- ACU-220 / ACU-280 controller with firmware version 6.06 (or newer),
- ARU-200 repeater.



The thermostat is not supported by the ACU-220 / ACU-280 controller connected to a VERSA series control panel.

The thermostat motor makes sounds when the thermostat is controlling the radiator valve.

1 Features

- Installation on valves with the M30x1.5mm threaded connection.
- Temperature adjustment in the range from 5°C to 30°C.
- 3 operating modes.
- Remote setting of the “Comfort temperature” or “Economy temperature” mode.
- Remote temperature setting for the “Comfort temperature” and “Economy temperature” modes.
- Choice between two temperature sensor types:
 - internal,
 - external (ABAX 2 system’s temperature sensor).
- Boost Heat function for fast heating.
- Anti-scale function.
- Open window detection.
- Anti-freeze protection.
- Child Lock.
- Thermostat status overview.
- LCD display for easier control and configuration.
- Battery charge level indicator.
- Encrypted two-way radio communication in the 868 MHz frequency band (AES standard).
- Transmission channel diversity – 4 channels for automatic selection of the one that will enable transmission without interference with other signals in the 868 MHz frequency band.
- Device firmware updated remotely.
- “ECO” option for longer battery life.
- Battery status control.
- Included elements:
 - adapter for mounting on a Danfoss RA valve,
 - reducer ring for easier installation on valves with smaller diameter.

2 Description

The ART-200 thermostat occupies one position on the list of wireless devices.

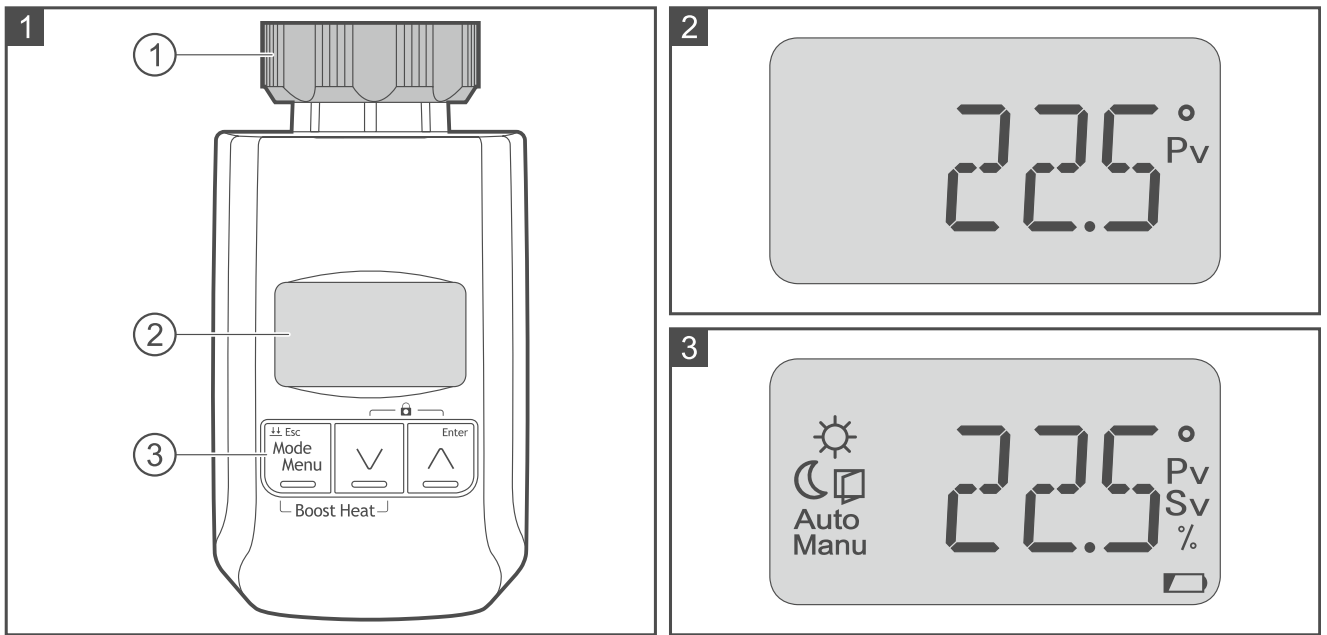

- ① union nut.
- ② LCD display.
- ③ keys to control and configure the thermostat (see: “Configuring the thermostat”).

LCD display

The symbols and messages shown on the display will help you control and configure the thermostat. When the thermostat is at work, the display shows temperature registered by the sensor (Fig. 2). See Fig. 3 for all symbols that can be displayed. See Table 1. for all possible messages.

Explanation of the symbols on Fig. 2 and 3:

- “Comfort temperature” operating mode.
- “Economy temperature” operating mode.
- open window detection enabled.
- Auto operating mode configured and switched remotely or manually.
- Manu operating mode configured and switched manually.
- ° temperature displayed in degrees Celsius.
- Pv temperature registered by the sensor is displayed.
- Sv temperature set for the selected operating mode is displayed.
- % valve position is displayed, where: 0% – valve fully closed, 100% – valve fully open.
- low batteries (battery voltage lower than 2.3 V).

Message	Explanation	Action to be taken
	Thermostat ready for calibration to be started.	Press or to start the calibration.
	Thermostat keys are disabled.	Press + to enable the keys (if the keys were disabled remotely, they can only be enabled remotely).





Message	Explanation	Action to be taken
	Thermostat adaptation in progress.	
	Anti-freeze protection is enabled (temperature dropped below 5°C).	
	Trouble with changing the valve position.	<ol style="list-style-type: none"> 1. Make sure the thermostat is mounted correctly on the valve and check the valve operation (dismount the thermostat and check the valve pin operation). 2. Restart the thermostat (remove the battery and insert it again).
	Incorrect operating range of the thermostat (calibration failure).	<ol style="list-style-type: none"> 1. Make sure the thermostat is mounted correctly on the valve. 2. Restart the thermostat (remove the battery and insert it again).
	Low battery – valve control disabled to protect against complete battery discharge.	Replace the battery.

Table 1.



The events labelled as F01, F02 and F03 will be indicated in the ABAX 2 system as no communication with the thermostat.

Keys

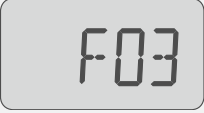
The keys are used to control and configure the thermostat.





Key	Function
	<p>short press – enter the operating mode menu / change the operating mode / switch between items in the advanced settings menu / switch between thermostat status information / exit the edit mode and save changes</p> <p>2 short presses – enter / exit the thermostat status overview</p> <p>long press – enter or exit the advanced settings menu / exit the edit mode without saving changes / disable the Boost Heat function</p>
	enter the operating mode menu / edit the operating mode / value down (short press – in steps, press and hold – stepless)
	enter the operating mode menu / edit the operating mode / start the function / value up (short press – in steps, press and hold – stepless)
	start the Boost Heat function
	enable / disable the keys

Table 2.

Radio communication

The thermostat connects to the controller at regular time intervals to provide information about its state (periodical communication). Additional communication takes place when the ART-200 thermostat is sending to the controller the settings adjusted manually.

Energy saving mode (ECO)

If you want to prolong the battery life, you can enable the “ECO” option in the device. When the “ECO” option is enabled, the periodical communication takes place every 3 minutes. This will prolong the battery life.

Battery status control

When the battery voltage is below 2.3 V, information about low battery will be sent during each transmission and the  symbol will be flashing on the display. When the voltage drops below 2.1 V, the thermostat will disable the valve control in order to protect the battery from complete discharge. The message **F03** will be displayed and the valve will be 25% open.

Operating modes

Comfort temperature – thermostat is to maintain room temperature at a comfortable level. This mode can be enabled remotely or manually.

Economy temperature – thermostat is to maintain room temperature at an energy-efficient level (e.g. when household members are at work or asleep at night). This mode can be enabled remotely or manually.

Manual setting of the valve position / temperature – radiator valve is set in a given position / thermostat is to maintain the set temperature. This mode can be enabled remotely or manually but the valve position / temperature can only be set manually.



The “Manual setting of the valve position / temperature” can be enabled remotely if the controller is connected to a SATEL alarm control panel. If the operating mode has been enabled remotely, the thermostat can only be controlled manually. Remote control is possible only after the mode is disabled remotely.

Thermostat calibration

When calibrating, the thermostat adjusts its actuator stroke to the radiator valve stroke. During calibration, the thermostat operating range is defined (the valve end positions, where: 0% = valve fully closed, 100% = valve fully open). The thermostat must be calibrated after it is installed on the valve and each time after batteries are replaced. The **CAL** message will be displayed when calibration is required.

Thermostat adaptation

After it is started, the thermostat will find the optimal valve position to reach and maintain the set temperature in the room. When the valve is open insufficiently, the room takes too long to heat up. When the valve is open too much, the room heats up fast but the temperature continues to rise beyond the set value and the room is too hot. The adaptation is repeated whenever the thermostat detects that the conditions in the room have changed in a way that can affect its operation. When the adaptation is in progress, the **ADPT** message and the temperature will be displayed alternately.

You can disable the adaptation function (see: “Edit the advanced settings” p. 11). When this function is disabled, the temperature will be regulated using the thermostat manufacturer settings.

Boost Heat

If the room temperature is too low and uncomfortable, you can enable the Boost Heat function to heat the room faster. The valve will then be fully open for a set time (by default: 15 minutes). The remaining time of the Boost Heat function will be displayed.

You can turn off the function yourself (see: “Keys” p. 4). If you do, the preset operating mode will be enabled.



The Boost Heat function has the highest priority. When it is enabled, other functions and settings are ignored.

Anti-scale protection

Scale can build up inside the valve when it remains unused for a long time. To prevent it, the thermostat will fully open the valve once every two weeks.

Open window detection

The thermostat can detect a sudden drop in temperature, e.g. caused by open window. The radiator valve will then be closed for a set time (by default: 30 minutes) or until the thermostat detects a rise in temperature. The  symbol will be flashing when the valve is closed as a result of open window detection.

You can restore the thermostat to the normal operating mode manually (see: “Edit the advanced settings” p. 11).

Anti-freeze protection

When temperature drops below 5°C, the thermostat will open the valve to prevent the radiator from freezing. The valve will remain open until the thermostat operating mode is changed or temperature rises to 8°C. When the anti-freeze protection is activated, the **A-FR** message will be displayed alternately with temperature registered by the sensor (labelled as Pv). When the protection is activated, this information is sent to the controller during periodical communication.

Temperature measurement correction

The thermostat can correct the temperature information provided by the internal sensor. The correction can be made in the range of $\pm 3,5^{\circ}\text{C}$.

Child lock

You can disable the thermostat keys to prevent the settings from being accidentally changed (e.g. by children at play). The keys can be disabled manually or remotely. You cannot enable the keys manually if they have been disabled remotely. The **LOC** message will be displayed for 20 seconds after disabling the keys and each time any key is pressed. If you enable the keys, information about the currently selected operating mode will be displayed.

3 Installation



There is a danger of battery explosion when using a different battery than recommended by the manufacturer, or handling the battery improperly. Do not crush the battery, cut it or expose it to high temperatures (throw it into the fire, put it in the oven, etc.).

Do not expose the battery to very low pressure due to the risk of battery explosion or leakage of flammable liquid or gas.

Be particularly careful during installation and replacement of the battery. The manufacturer is not liable for the consequences of incorrect installation of the battery.

The used batteries must not be discarded, but should be disposed of in accordance with the existing rules for environment protection.

The device is designed for indoor installation. When in use, the ART-200 thermostat must be located within the radio range of the ABAX 2 controller. Thick walls, metal partitions, etc. will reduce the range of the radio signal. Use the ARF-200 tester to check the level of radio signal. Place the tester close to the valve on which you want to install the thermostat. If the radio signal level indicated by the tester is higher than 40%, you can install the thermostat there.

The thermostat is fitted for radiator valves with the M30 x 1.5 mm threaded connection. It is compatible with most radiator valves on the market. In order to install the thermostat on the Danfoss RA valve, use the supplied adapter.



You do not need any special tools to install the thermostat. Disconnecting the heating system is not required.

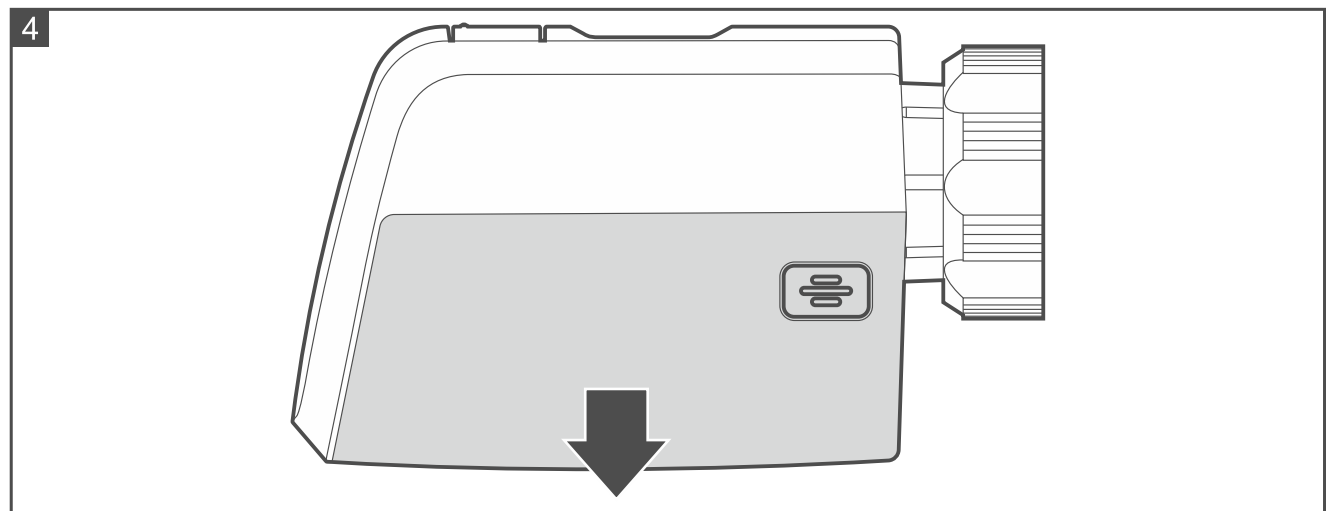

1. Use your fingers to press down the  symbols on both sides of the battery cover (gray element on Fig. 4). Pull to remove the cover.



2. Install two 1,5 V LR6 AA alkaline batteries (they are not supplied with the thermostat). When the batteries are installed, the **CAL** message will be displayed. The actuator rod will be completely withheld inside the thermostat cover so that it is possible to install the thermostat on the valve.
3. Add the thermostat to the wireless system (see the ABAX 2 controller manual). For that, you need the thermostat serial number. You will find it on a sticker inside the battery cover.
4. Replace the battery cover.
5. Install the thermostat on the valve (see: "Installation on M30x1.5 mm valve" or "Installation on Danfoss RA valve"). If the actuator rod (labelled as ) is not completely withheld inside the thermostat cover, remove the batteries before installation, insert them back and wait until the rod hides inside the cover.



Before you remove the old thermostatic head, make sure to turn it several times from minimum to maximum position and back. Unscrew the old thermostat when it is in the maximum position. When the thermostat is removed, the valve pin should be fully extended.

6. Press  or . Calibration will begin. Information about the currently selected operating mode of the thermostat will be displayed (by default: "Comfort temperature"). When calibration is in progress, you can configure the thermostat settings (see: "Configuring the thermostat").

3.1 Installation on M30x1.5 mm valve

1. Place the thermostat on the valve (Fig. 5). Adjust the thermostat position so that the user can easily access the keys and the LCD display.

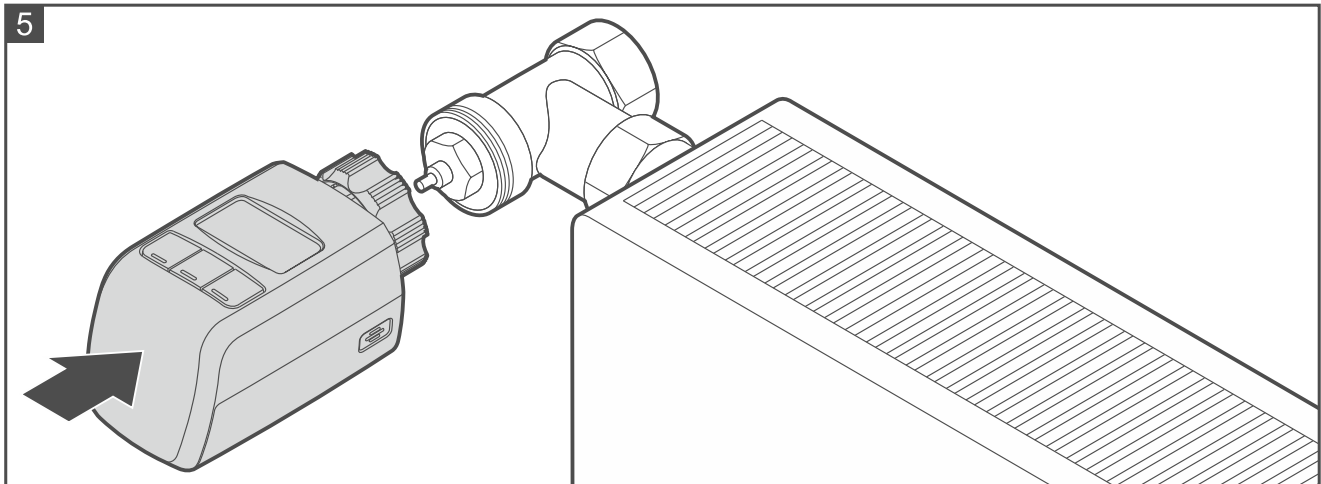

2. Tighten the thermostat on the valve using the union nut (Fig. 6). Do it by hand.
3. If the thermostat is seated loosely on the valve, use the reducer ring. Unscrew the thermostat, place the reducer ring inside its flange (Fig. 7), then repeat points 1 and 2.

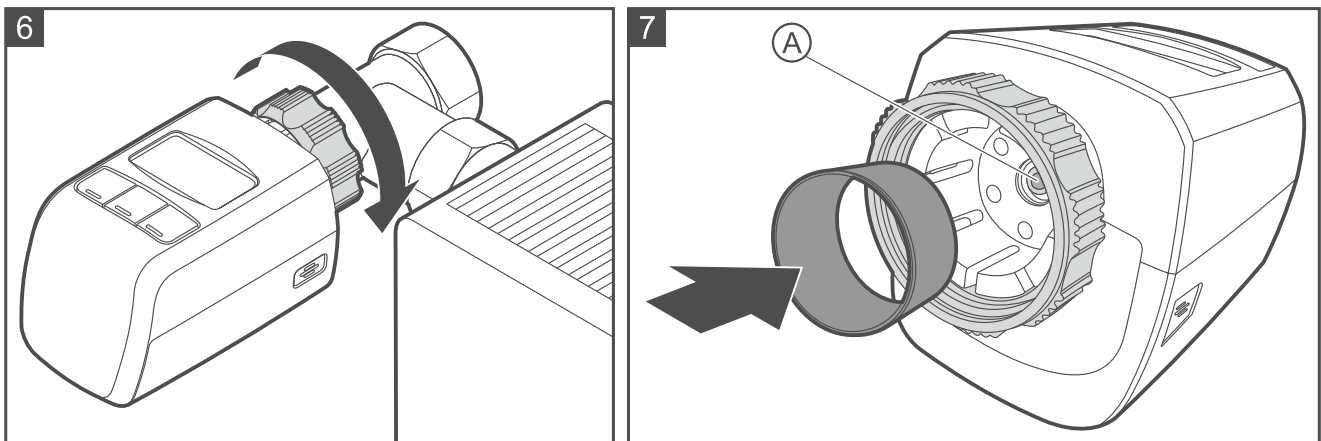

3.2 Installation on Danfoss RA valve

1. Fasten the adapter on the valve.
 - 1.1. Place the adapter on the valve (Fig. 8).
 - 1.2. Bend open the adapter clamp with a screwdriver and press the adapter against the valve flange (Fig. 9). The valve flange is labelled as (A) on Fig. 9. Make sure the bumps inside the adapter ((C) on Fig. 9) line up with the notches on the valve body ((B) on Fig. 9).
 - 1.3. Fasten the adapter clamp with a screw (Fig. 10).



Be careful not to pinch your fingers with the adapter clamp.

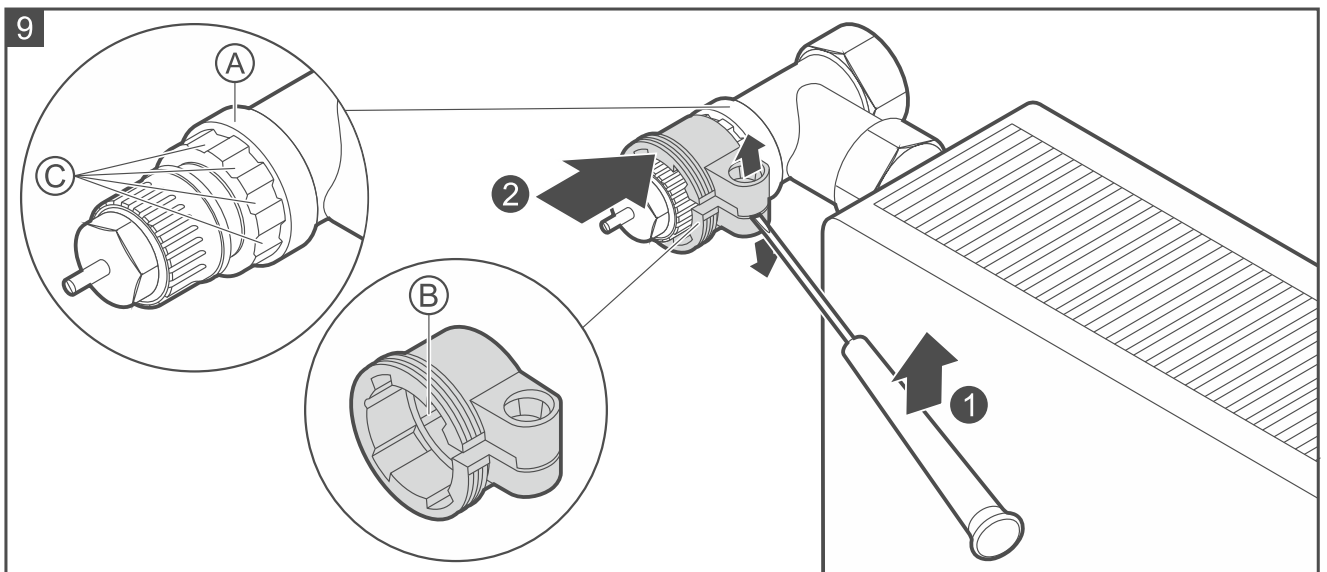
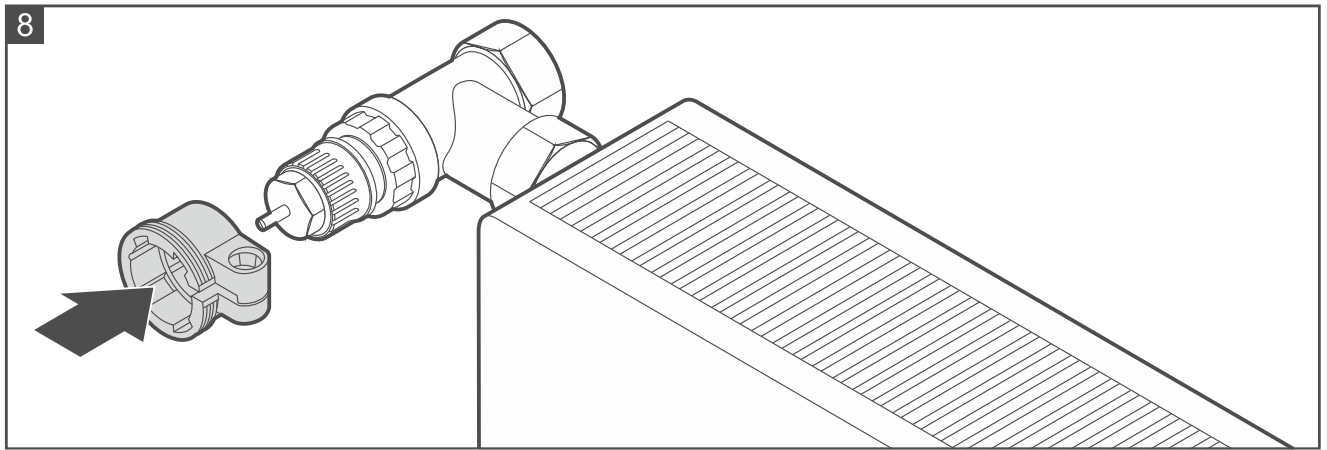

2. Place the thermostat on the valve (Fig. 11). Adjust the thermostat position so that the user can easily access the keys and the LCD display.
3. Tighten the thermostat on the adapter using the union nut (Fig. 12). Do it by hand.
4. If the thermostat is seated loosely on the valve, use the reducer ring. Unscrew the thermostat, place the reducer ring inside its flange (Fig. 7), then repeat points 2 and 3.

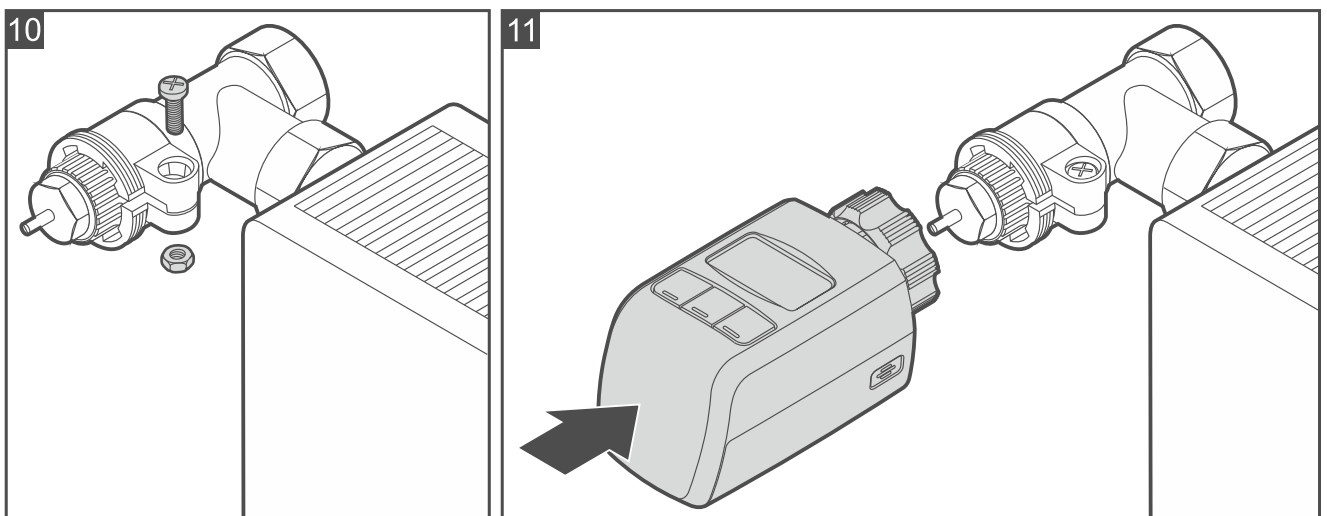

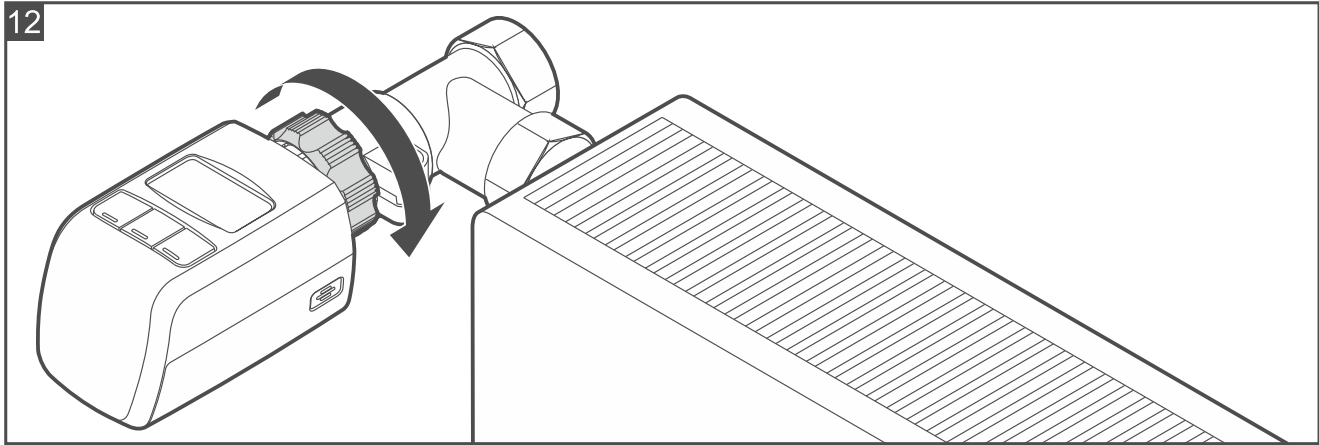

4 Configuring the thermostat

4.1 Remote configuration

To find out how to configure the thermostat, please refer to the ABAX 2 controller manual.

4.2 Configuration using the keys

Enter the operating mode menu

Press any key. Information about the current operating mode of the thermostat will be displayed (see: Table 3). Depending on the operating mode, the information may include temperature in degrees Celsius or valve position in percentage.

Change the operating mode

Each press of the  key will change the operating mode to the next one. The operating modes are arranged in sequence presented in Table 3. Keep pressing the key until you select the desired operating mode.









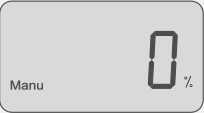

Operating mode	
	Comfort temperature (T2)
	Economy temperature (T1)
	Manual setting of the valve position / temperature

Table 3.

Edit the operating mode settings

1. Enter the operating mode menu.
2. Use the  key to select the operating mode whose settings you want to edit.

3. Press  or  to start editing. The displayed value (temperature / valve position) will start flashing.
4. Use  or  to set the temperature / valve position. When editing the “Manual setting of the valve position / temperature” mode, if you want to set the temperature, keep pressing the key until the valve position (percentage) switches to temperature (degrees).
5. Press  to save the changes made (to quit, press and hold ).

Exit the operating mode menu

Wait about 20 seconds. The thermostat will exit the operating mode menu. The temperature registered by the sensor will be displayed (labelled as Pv).











Any changes made in the settings will only be saved after the thermostat exits the operating mode menu. If you remove the batteries before 20 seconds pass since your last activity in the operating mode menu, the changes will not be saved.

Enter the advanced settings menu

1. Press any key to enter the operating mode menu.
2. Press and hold . The first available function will be displayed.

Edit the advanced settings

1. Enter the advanced settings menu.
2. Use the  key to select the function you want to start. The functions are arranged in sequence presented in Table 4.
3. Press  to start the function. The current setting will be displayed.
4. Use  and  to change the settings.
5. Press  to save the changes made (to quit, press and hold ). You will return to the list of functions.

Function	Description
<p>ESC AER</p>	<p>Restoring normal thermostat operation after open window detection</p> <p>This function is available when the valve is closed as a result of open window detection.</p> <p>Start the function and press  to restore the thermostat to the normal operating mode or press  to exit the function.</p>
<p>BOOST</p>	<p>Duration of the Boost Heat function</p> <p>You can program from 1 to 240 minutes.</p> <p>By default: 15 minutes.</p>





 AER	Valve closing time after open window detection You can program from 0 to 60 minutes (0 – open window detection disabled). By default: 30 .
PI ADAPT	Thermostat adaptation You can select ON (function enabled) or OFF (function disabled). By default: ON .
FACT RES	Restoring default settings Start the function and press  to restore default settings or press  to quit.



Table 4.



Exit the advanced settings menu

Press and hold . Information about the currently selected operating mode will be displayed.

 *If you take no action for 20 seconds, the thermostat will exit the menu automatically. Temperature registered by the sensor will be displayed (labelled as Pv).*



5 Starting the Boost Heat function

Press  and  simultaneously. Information about the remaining time of the function will be displayed (e.g. B030 – 30 minutes). When the time runs out, the selected operating mode will be resumed.

If you press  and  simultaneously when the function is running, the countdown will be restarted.

If you want to turn off the function, press and hold .

6 Thermostat status overview

1. Enter the operating mode menu. Information about the currently selected operating mode will be displayed.
2. Press  2 times. Information about temperature registered by the sensor will be displayed.
3. Press  to go to the next item. The items are displayed in sequence presented in Table 5 (temperature is next after thermostat serial number).

Available thermostat status information

Temperature registered by the sensor (Pv).

Current valve position, where: 0% – valve fully closed, 100% – valve fully open.

Current battery voltage (accuracy up to 0.01 V).

Current adaptation status:

ADAPT PREP – adaptation was never started,

ADAPT IP – adaptation in progress,

ADAPT END – adaptation concluded,

ADAPT OFF – adaptation disabled (temperature will be regulated using the thermostat manufacturer settings).

Thermostat serial number.



Table 5.

4. Press  2 times to exit the overview. Information about the currently selected operating mode will be displayed.



If you take no action for 20 seconds, the thermostat will exit the function automatically. Temperature registered by the sensor will be displayed (labelled as Pv).

7 Disabling the keys

Press the  and  keys simultaneously to disable / enable the keys.

8 Specifications

Operating frequency band	868.0 MHz ÷ 868.6 MHz
Radio communication range (in open area)	up to 1000 m
Batteries	2 x 1.5 V LR6 AA
Battery life expectancy	up to 2 years
Temperature measurement range	-10°C...+50°C
Temperature measurement accuracy	±0.1°C
Temperature adjustment range	5°C...30°C
Temperature adjustment accuracy	±0,5°C
Standby current consumption	98 µA
Maximum current consumption	80 mA
Operating temperature range	-10°C...+55°C
Maximum humidity	93±3%
Enclosure dimensions	55 x 102 x 61 mm
Weight	136 g