



Wireless Dual-Tech Detector

User's Manual







Foreword

General

This manual introduces the installation, functions and operations of the Wireless Dual-Tech Detector (hereinafter referred to as the "dual-tech detector"). Read carefully before using the device, and keep the manual safe for future reference.

Safety Instructions

The following signal words might appear in the manual.

Signal Words	Meaning
 DANGER	Indicates a high potential hazard which, if not avoided, will result in death or serious injury.
 WARNING	Indicates a medium or low potential hazard which, if not avoided, could result in slight or moderate injury.
 CAUTION	Indicates a potential risk which, if not avoided, could result in property damage, data loss, reductions in performance, or unpredictable results.
 TIPS	Provides methods to help you solve a problem or save time.
 NOTE	Provides additional information as a supplement to the text.

Revision History

Version	Revision Content	Release Time
V1.0.0	First release.	November 2022

Privacy Protection Notice

As the device user or data controller, you might collect the personal data of others such as their face, fingerprints, and license plate number. You need to be in compliance with your local privacy protection laws and regulations to protect the legitimate rights and interests of other people by implementing measures which include but are not limited: Providing clear and visible identification to inform people of the existence of the surveillance area and provide required contact information.

About the Manual

- The manual is for reference only. Slight differences might be found between the manual and the product.
- We are not liable for losses incurred due to operating the product in ways that are not in compliance with the manual.
- The manual will be updated according to the latest laws and regulations of related jurisdictions. For detailed information, see the paper user's manual, use our CD-ROM, scan the QR code or visit our official website. The manual is for reference only. Slight differences might be found between

the electronic version and the paper version.

- All designs and software are subject to change without prior written notice. Product updates might result in some differences appearing between the actual product and the manual. Please contact customer service for the latest program and supplementary documentation.
- There might be errors in the print or deviations in the description of the functions, operations and technical data. If there is any doubt or dispute, we reserve the right of final explanation.
- Upgrade the reader software or try other mainstream reader software if the manual (in PDF format) cannot be opened.
- All trademarks, registered trademarks and company names in the manual are properties of their respective owners.
- Please visit our website, contact the supplier or customer service if any problems occur while using the device.
- If there is any uncertainty or controversy, we reserve the right of final explanation.

Important Safeguards and Warnings

This section introduces content covering the proper handling of the dual-tech detector, hazard protection, and protection of property damage. Read carefully before using the dual-tech detector, and comply with the guidelines when using it.

Operation Requirements



- Make sure that the power supply of the dual-tech detector works properly before use.
- Do not pull out the power cable of the dual-tech detector while it is powered on.
- Only use the dual-tech detector within the rated power range.
- Transport, use and store the device under allowed humidity and temperature conditions.
- Prevent liquids from splashing or dripping on the device. Make sure that there are no objects filled with liquid on top of the dual-tech detector to avoid liquids flowing into it.
- Do not disassemble the dual-tech detector.

Installation Requirements



- Connect the dual-tech detector to the adapter before power on.
- Strictly abide by local electrical safety standards, and make sure that the voltage in the area is steady and conforms to the power requirements of the dual-tech detector.
- Do not connect the dual-tech detector to more than one power supply. Otherwise, the might become damaged.



- Observe all safety procedures and wear required protective equipment provided for your use while working at heights.
- Do not expose the dual-tech detector to direct sunlight or heat sources.
- Do not install the dual-tech detector in humid, dusty or smoky places.
- Install the dual-tech detector in a well-ventilated place, and do not block the ventilator of the device.
- Use the power adapter or case power supply provided by the device manufacturer.
- The power supply must conform to the requirements of ES1 in IEC 62368-1 standard and be no higher than PS2. Note that the power supply requirements are subject to the device label.
- Connect class I electrical appliances to a power socket with protective earthing.

Table of Contents

Foreword	I
Important Safeguards and Warnings.....	III
1 Introduction	1
1.1 Overview	1
1.2 Technical Specifications.....	1
2 Checklist.....	3
3 Design.....	4
3.1 Appearance.....	4
3.2 Dimensions	5
4 Power On.....	6
5 Adding the Wireless Dual-Tech Detector to the Hub.....	7
6 Installation.....	8
6.1 Field of View.....	8
6.2 Wall Mount.....	8
6.3 Corner Mount.....	9
7 Replacing the Battery.....	11
8 Configuration	12
8.1 Viewing Status	12
8.2 Configuring the Dual-tech Detector	13
Appendix 1 Cybersecurity Recommendations.....	16

1 Introduction

1.1 Overview

Wireless Dual-tech Detector is a wireless motion detector designed for indoor use. It can detect a human moving within 12 m of the detector.

1.2 Technical Specifications

This section contains technical specifications of the dual-tech detector. Please refer to the ones that correspond with your model.

Table 1-1 Technical specification

Type	Parameter	Description	
Port	Indicator Light	1 × green alarm indicator	
	Button	1 × power switch	
Function	Tamper Alarm	Yes	
	Remote Update	Cloud update	
	Signal Strength	Detects signal strength.	
	Low Battery Alarm	Yes	
Wireless	Carrier Frequency	DHI-ARD2231-W2(868): 868.0 MHz–868.6 MHz	DHI-ARD2231-W2: 433.1 MHz–434.6 MHz
	Communication Distance	DHI-ARD2231-W2(868): Up to 1,600 m (5249.34 ft) in an open space	DHI-ARD2231-W2: Up to 1200 m (3937.01 ft) in an open space
	Transmit Power	DHI-ARD2231-W2(868): Limit 25 mW	DHI-ARD2231-W2: Limit 10 mW
	Communication Mechanism	Two-way	
	Encryption Mode	AES128	
	Frequency Hopping	Yes	
	Temperature	Measuring Range	−15 °C to +65 °C (+18.8 °F to +149 °F) (indoor)
Measuring Precision		± 1 °C (± 33.8 °F)	
Technical	Detection Mode	PIR + Microwave	
	Sensor	Dual-element low-noise PIR sensor, microwave sensor	

Type	Parameter	Description		
	Test Mode	Yes		
	Detection Range	12 m (39.37 ft) (90°) with installation height of 2.2 m (7.21 ft)		
	Detection Speed	0.3 m/s–3 m/s (0.98 ft/s–9.84 ft/s)		
	Pet Immunity Level	≤ 18 kg (39.68 lb), height < 50 cm (19.68 ft)		
	White Light Resistance Level	2000 lx		
	Two-way Digital Temperature Compensation	Yes, no attenuation of detection distance in high temperature		
	Sensitivity	3 levels adjustable		
General	Power Supply	CR123A*1		
	Consumption	Quiescent current 11 uA Max. current 69 mA		
	Battery Life	3 years(if triggered 10 times a day with a battery efficiency of 70%)		
	Power Consumption	DHI-ARD2231-W2(868): Max. 615 mW	DHI-ARD2231-W2: Max. 640 mW	
	Operating Environment	-10 °C to +55 °C (+14 °F to +131 °F) (indoor) -10 °C to +40 °C (+14 °F to +104 °F) (certified)		
	Operating Humidity	10%–90% (RH)		
	Product Dimensions	104.0 mm× 60.0 mm× 50.0 mm (4.09" × 2.36" × 1.97")		
	Packaging Dimensions	95 mm× 59.5 mm× 30.5 mm (3.74" × 2.34" × 1.20")		
	Installation	Wall mount		
	Net Weight	106 g		
	Gross Weight	184 g		
	Casing Material	PC + ABS		
	Certifications	DHI-ARD2231-W2(868):CE	DHI-ARD2231-W2: <ul style="list-style-type: none"> ● CE ● FCC 	

2 Checklist

Figure 2-1 Checklist

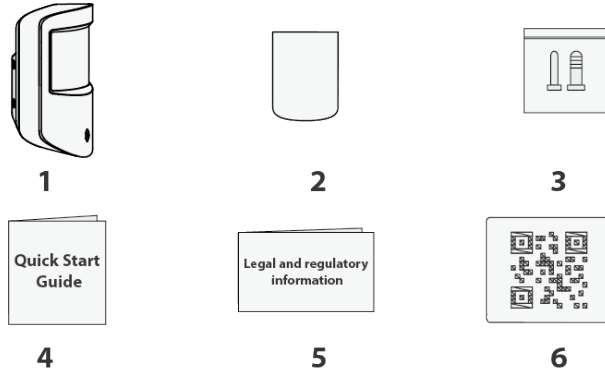

Table 2-1 Checklist

No.	Item Name	Quantity	No.	Item Name	Quantity
1	Wireless dual-tech detector	1	4	Quick start guide	1
2	Double-sided adhesive tape	1	5	Legal and regulatory information	1
3	Screw package	1	6	QR code	1

3 Design

3.1 Appearance

Figure 3-1 Appearance

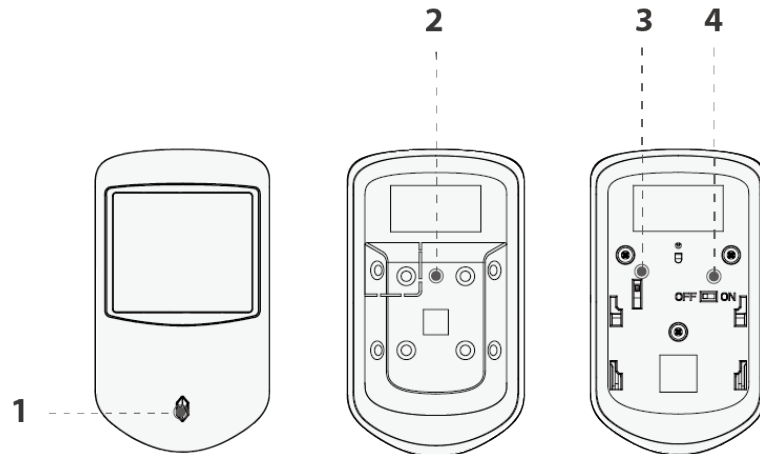
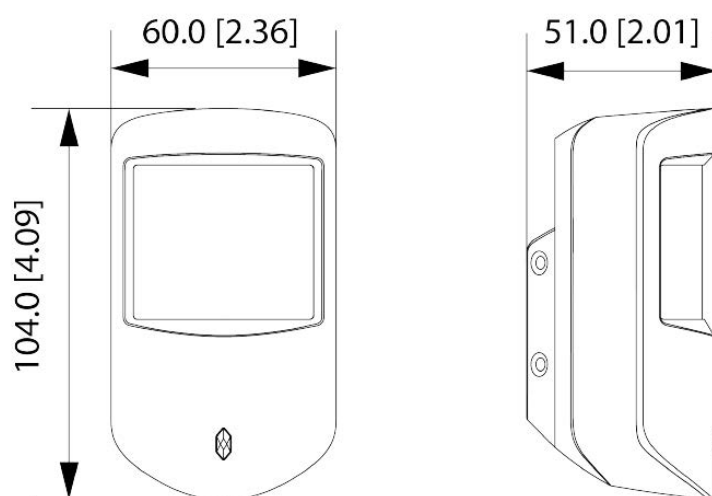

Table 3-1 Structure

No.	Name	Description
1	Indicator	<ul style="list-style-type: none"> Flashes green quickly: Pairing mode or reduced sensitivity mode. Solid green: An alarm event was triggered. Solid green for 2 seconds: Pairing successful. Slowly flashes green for 3 seconds: Pairing failed. Flashes green quickly for 100 seconds, and then off: sensitivity mode.
2	On/off switch	Turn on or turn off the device.
3	Tamper switch	When the tamper switch is released, the tamper alarm will be triggered.
4	Back cover	If the back cover is opened, the tamper alarm will be triggered.

3.2 Dimensions

Figure 3-2 Dimensions (mm [inch])



4 Power On

Step 1 Remove the back cover of the dual-tech detector.

Figure 4-1 Remove the back cover

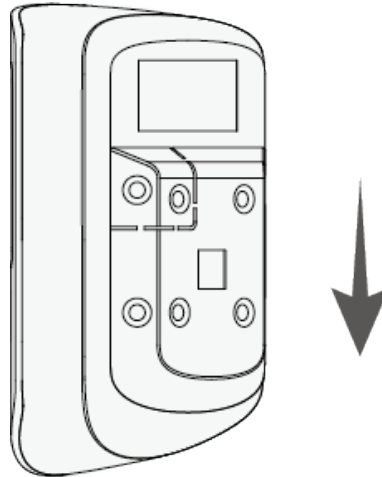

Step 2 Turn on the dual-tech detector.

Figure 4-2 Turn on the dual-tech detector

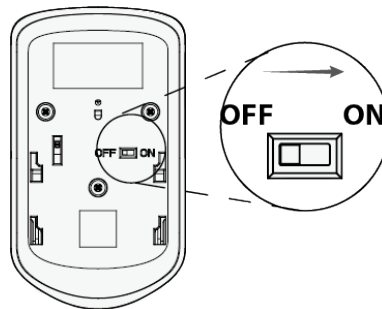

5 Adding the Wireless Dual-Tech Detector to the Hub

Before you connect dual-tech detector to the hub, install the DMSS app to your phone. This manual uses iOS as an example.



- Make sure that the version of the DMSS app is 1.99.300 or later, and the hub is V1.001.0000004.0.R.221030 or later.
- Make sure that you have already created an account, and added the hub to DMSS.
- Make sure that the hub has a stable internet connection.
- Make sure that the hub is disarmed.

Step 1 Go to the hub screen, and then tap **Peripheral** to add the dual-tech detector.

Step 2 Tap **+** to scan the QR code at the bottom of the dual-tech detector, and then tap **Next**.

Step 3 Tap **Next** after the dual-tech detector has been found.

Step 4 Follow the on-screen instructions and switch the dual-tech detector to on, and then tap **Next**.

Step 5 Wait for the pairing.

Step 6 Customize the name of the dual-tech detector, and select the area, and then tap **Completed**.

6 Installation

The dual-tech detector supports wall mount and corner mount.

Figure 6-1 Installation location

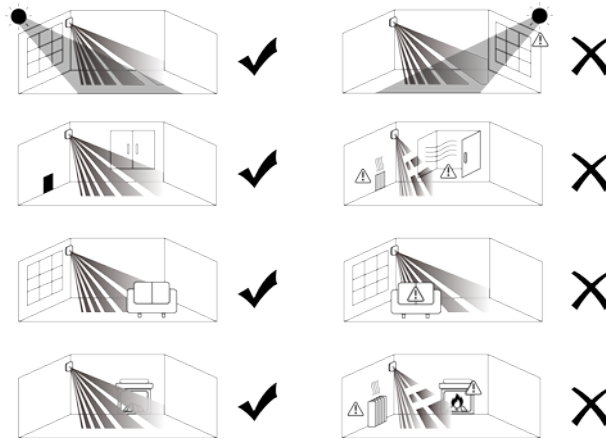

6.1 Field of View

Field of view of the dual-tech are shown below.



When installing and using the dual-tech, make sure there are no objects partially or fully obscuring the detector's field of view.

Figure 6-2 Field of view

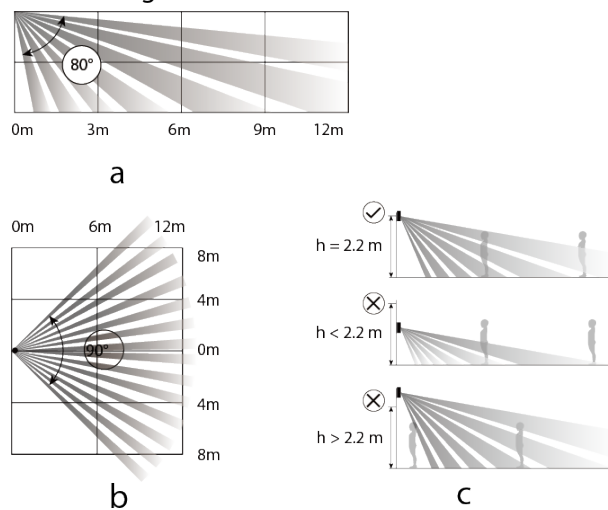

6.2 Wall Mount

Step 1 Drill 4 holes into the wall according to the hole positions of the dual-tech detector, and then put the expansion bolts into the holes.

Figure 6-3 Drill holes

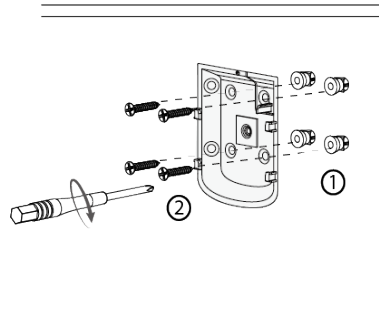

Step 2 Attach the dual-tech detector to the back cover.

Figure 6-4 Attach the detector to the back cover

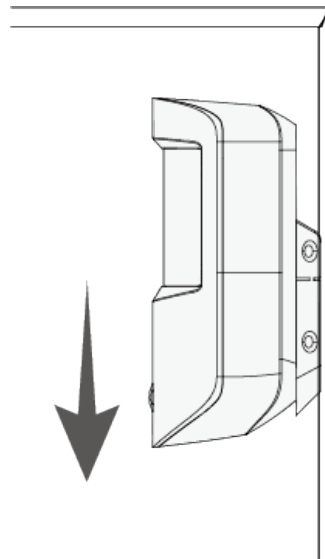

6.3 Corner Mount

Step 1 Drill 4 holes into the wall according to the hole positions of the dual-tech detector, and then put the expansion bolts into the holes.

Figure 6-5 Drill holes

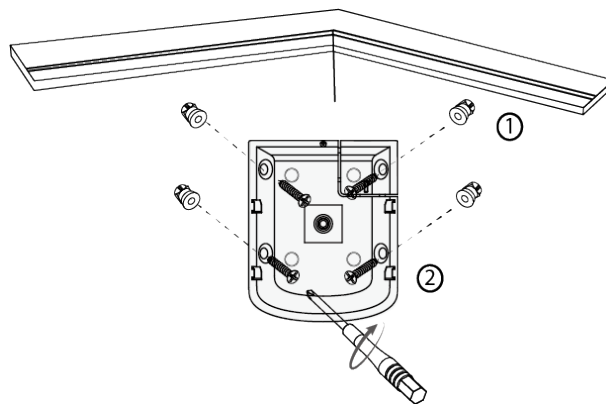

Step 2 Attach the dual-tech detector to the back cover.

Figure 6-6 Attach the detector to the back cover

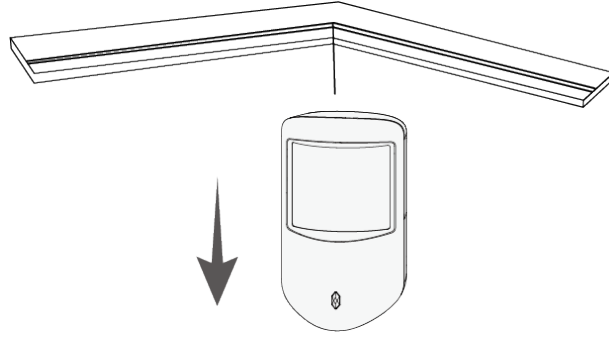

7 Replacing the Battery

The battery has been installed when leaving the factory, and the dual-tech detector can be used directly. If the battery is dead, you need to replace the battery.

Step 1 Open the back cover of the dual-tech detector.

Step 2 Replace the battery.

When replacing the battery, make sure that the side marked with "+" faces the back cover of the devices.

Figure 7-1 Replace the battery

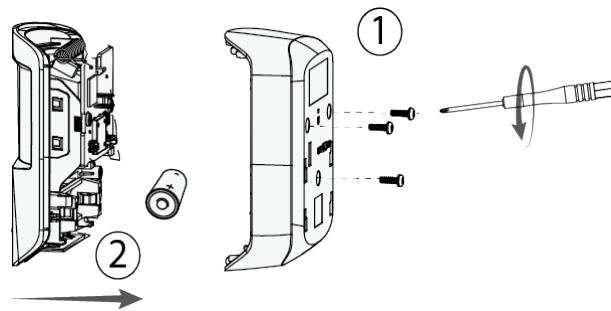

Step 3 Close the back cover of the dual-tech detector.

Figure 7-2 Close the back cover

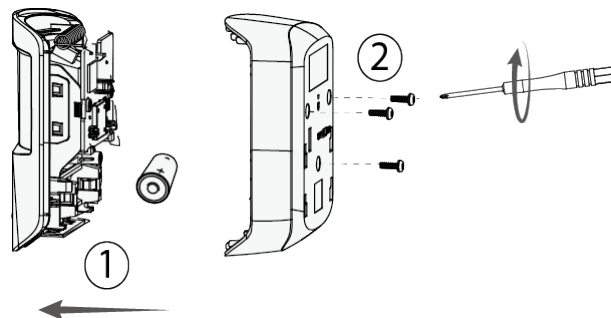

















8 Configuration

You can view and edit general information of the dual-tech detector.

8.1 Viewing Status

On the hub screen, select a dual-tech detector from the peripheral list, and then you can view the status of the dual-tech detector.

Table 8-1 Status

Parameter	Value
Temporary Deactivate	The status for whether the functions of the dual-tech detector are enabled or disabled. <ul style="list-style-type: none"> ● : Enable. ● : Only disable tamper alarm. ● : Disable.
Temperature	The temperature of the environment.
Signal Strength	The signal strength between the hub and the dual-tech detector. <ul style="list-style-type: none"> ● : Low. ● : Weak. ● : Good. ● : Excellent. ● : No.
Battery Level	The battery level of the dual-tech detector. <ul style="list-style-type: none"> ● : Fully charged. ● : Sufficient. ● : Moderate. ● : Insufficient. ● : Low.
Tamper Status	The tamper status of the dual-tech detector, which reacts to the detachment of the body.
Online Status	Online and offline status of the dual-tech detector. <ul style="list-style-type: none"> ● : Online. ● : Offline.
Entering Delay Time	Entrance delay time.
Exiting Delay Time	Exit delay time
24 H Protection Zone Status	Active status of the 24 h protection zone. <ul style="list-style-type: none"> ● : Enable. ● : Disable.
Sensitivity	Adjust the sensitivity level of motion detection. The higher the value, the easier the motion is detected.

Parameter	Value
Transmit through Repeater	The status of whether the dual-tech detector forwards its messages to the hub through the repeater.
Program Version	The program version of the dual-tech detector.

8.2 Configuring the Dual-tech Detector









On the hub screen, select a dual-tech detector from the peripheral list, and then tap  to configure the parameters of the dual-tech detector.

Table 8-2 Parameter description

Parameter	Description
Device Configuration	<ul style="list-style-type: none"> View dual-tech detector name, type, SN and device model. Edit dual-tech detector name, and then tap Save to save configuration.
Area	Select the area to which the dual-tech detector is assigned.
Temporary Deactivate	<p>Whether send commands to the alarm hub.</p> <ul style="list-style-type: none"> Tap Enable, and then the dual-tech detector will send commands to the hub. Enable is set by default. Tap Only Disable Tamper Alarm, and then the system will only ignore tamper alarm messages. Tap Disable, and then the dual-tech detector will not send commands to the hub.
LED Indicator	<p>LED Indicator is enabled by default.</p>  <p>If LED Indicator is disabled, the LED indicator will remain off regardless of whether the dual-tech detector is functioning normally or not.</p>
24 H Protection Zone	<ul style="list-style-type: none"> If 24 H Protection Zone is enabled, even the system is disarmed, the dual-tech detector can be armed and detects motion. If 24 H Protection Zone is disabled, only when the system is armed, the dual-tech detector can be armed and detects motion. The dual-tech detector will not be armed immediately, it will begin before the end of the ping interval of the hub-detector (60 seconds by default).  <p>You can go to the hub's screen to configure the ping interval of the hub-detector. For details, see the user's manual of the hub.</p>
Home Mode	Enable the Home Mode , and then the selected peripherals under the hub will be armed.

Parameter	Description
Delay Mode under Home Mode	Enable the Delay Mode under Home Mode , the selected peripherals under the hub will be armed and the alarm will not be triggered until the end of customized delay time.  Only enable Home Mode first can Delay Mode under Home Mode take effect.
Delay Time	The system provides you with time to leave or enter the protection zone without alarm. <ul style="list-style-type: none"> Delay Time for Entering Arming Mode: When you enter the zone, if you do not disarm the system before the delay ends, an alarm will be triggered.  Make sure that the delay time for entering arming mode is no longer than 45 seconds in order to comply with EN50131-1. Delay Time for Exiting Arming Mode: When you are in the zone and arm the system, if you do not leave the zone before the delay ends, an alarm will be triggered. You can select from 0 s to 120 s.  The arming mode will be effective after the delay time.
Sensitivity	<ul style="list-style-type: none"> Adjust sensitivity level of motion detection. Select from low, medium and high.
Siren Linkage	When an alarm is triggered, the peripherals will report the alarm events to the hub and alert with siren.
Alarm-video Linkage	When an alarm is triggered, the peripherals will report the alarm events to the hub and then will link events.
Video Channel	Select the video channel as needed.
Signal Strength Detection	Test the current signal strength.
Detector Test	Tap Start Detection to test the status of the dual-tech detector.  <ul style="list-style-type: none"> The detector test will not begin immediately. it will begin before the end of the ping interval of the hub-detector (60 seconds by default). You can configure the hub-detector ping interval on the hub.

Parameter	Description
Transmit Power	<ul style="list-style-type: none"> • Select from high, low, and automatic. • The higher transmission power levels are, the further transmissions can travel, but power consumption increases.  <ul style="list-style-type: none"> • If you select Low, the dual-tech detector will enter into reduced sensitivity mode. • We recommend you selecting Low when installing the device to test the signal strength of the installation location, and then adjusting to High or Automatic. • The indicator flashes when setting as Low.
User's Manual	View user's manual of the device.
Cloud Update	Update online.
Delete	Delete the dual-tech detector.  Go to the hub screen, select the dual-tech detector from the peripheral list, and then swipe left to delete it.

Appendix 1 Cybersecurity Recommendations

Cybersecurity is more than just a buzzword: it's something that pertains to every device that is connected to the internet. IP video surveillance is not immune to cyber risks, but taking basic steps toward protecting and strengthening networks and networked appliances will make them less susceptible to attacks. Below are some tips and recommendations from Dahua on how to create a more secured security system.

Mandatory actions to be taken for basic device network security:

1. Use Strong Passwords

Please refer to the following suggestions to set passwords:

- The length should not be less than 8 characters.
- Include at least two types of characters; character types include upper and lower case letters, numbers and symbols.
- Do not contain the account name or the account name in reverse order.
- Do not use continuous characters, such as 123, abc, etc.
- Do not use overlapped characters, such as 111, aaa, etc.

2. Update Firmware and Client Software in Time

- According to the standard procedure in Tech-industry, we recommend to keep your device (such as NVR, DVR, IP camera, etc.) firmware up-to-date to ensure the system is equipped with the latest security patches and fixes. When the device is connected to the public network, it is recommended to enable the "auto-check for updates" function to obtain timely information of firmware updates released by the manufacturer.
- We suggest that you download and use the latest version of client software.

"Nice to have" recommendations to improve your device network security:

1. Physical Protection

We suggest that you perform physical protection to device, especially storage devices. For example, place the device in a special computer room and cabinet, and implement well-done access control permission and key management to prevent unauthorized personnel from carrying out physical contacts such as damaging hardware, unauthorized connection of removable device (such as USB flash disk, serial port), etc.

2. Change Passwords Regularly

We suggest that you change passwords regularly to reduce the risk of being guessed or cracked.

3. Set and Update Passwords Reset Information Timely

The device supports password reset function. Please set up related information for password reset in time, including the end user's mailbox and password protection questions. If the information changes, please modify it in time. When setting password protection questions, it is suggested not to use those that can be easily guessed.

4. Enable Account Lock

The account lock feature is enabled by default, and we recommend you to keep it on to guarantee the account security. If an attacker attempts to log in with the wrong password several times, the corresponding account and the source IP address will be locked.

5. Change Default HTTP and Other Service Ports

We suggest you to change default HTTP and other service ports into any set of numbers between

1024–65535, reducing the risk of outsiders being able to guess which ports you are using.

6. **Enable HTTPS**

We suggest you to enable HTTPS, so that you visit Web service through a secure communication channel.

7. **MAC Address Binding**

We recommend you to bind the IP and MAC address of the gateway to the device, thus reducing the risk of ARP spoofing.

8. **Assign Accounts and Privileges Reasonably**

According to business and management requirements, reasonably add users and assign a minimum set of permissions to them.

9. **Disable Unnecessary Services and Choose Secure Modes**

If not needed, it is recommended to turn off some services such as SNMP, SMTP, UPnP, etc., to reduce risks.

If necessary, it is highly recommended that you use safe modes, including but not limited to the following services:

- SNMP: Choose SNMP v3, and set up strong encryption passwords and authentication passwords.
- SMTP: Choose TLS to access mailbox server.
- FTP: Choose SFTP, and set up strong passwords.
- AP hotspot: Choose WPA2-PSK encryption mode, and set up strong passwords.

10. **Audio and Video Encrypted Transmission**

If your audio and video data contents are very important or sensitive, we recommend that you use encrypted transmission function, to reduce the risk of audio and video data being stolen during transmission.

Reminder: encrypted transmission will cause some loss in transmission efficiency.

11. **Secure Auditing**

- Check online users: we suggest that you check online users regularly to see if the device is logged in without authorization.
- Check device log: By viewing the logs, you can know the IP addresses that were used to log in to your devices and their key operations.

12. **Network Log**

Due to the limited storage capacity of the device, the stored log is limited. If you need to save the log for a long time, it is recommended that you enable the network log function to ensure that the critical logs are synchronized to the network log server for tracing.

13. **Construct a Safe Network Environment**

In order to better ensure the safety of device and reduce potential cyber risks, we recommend:

- Disable the port mapping function of the router to avoid direct access to the intranet devices from external network.
- The network should be partitioned and isolated according to the actual network needs. If there are no communication requirements between two sub networks, it is suggested to use VLAN, network GAP and other technologies to partition the network, so as to achieve the network isolation effect.
- Establish the 802.1x access authentication system to reduce the risk of unauthorized access to private networks.
- Enable IP/MAC address filtering function to limit the range of hosts allowed to access the

device.

More information

Please visit Dahua official website security emergency response center for security announcements and the latest security recommendations.

ENABLING A SAFER SOCIETY AND SMARTER LIVING

ZHEJIANG DAHUA VISION TECHNOLOGY CO., LTD.

Address: No.1199 Bin'an Road, Binjiang District, Hangzhou, P. R. China | Website: www.dahuasecurity.com | Postcode: 310053

Email: overseas@dahuatech.com | Fax: +86-571-87688815 | Tel: +86-571-87688883