

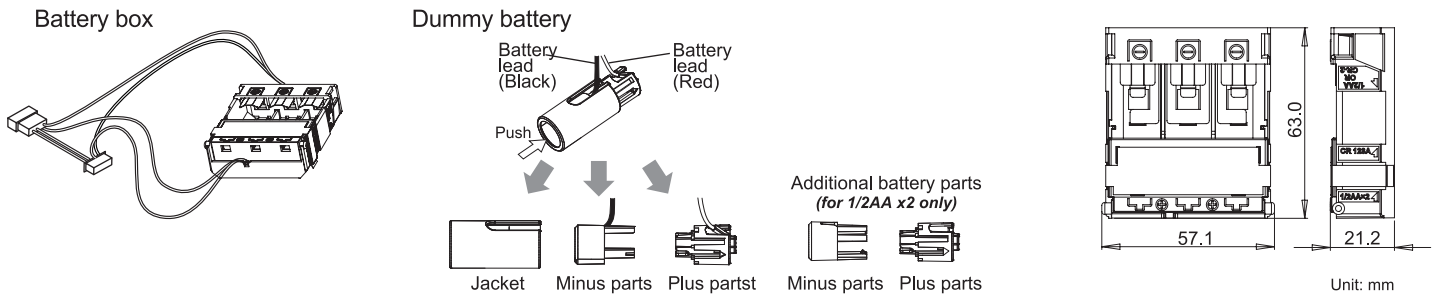

RBB-01

OPTIONS

1 Parts identifications and dimensions



2 Preparations

To use the detector, a wireless transmitter and batteries should be prepared. First check the following flowchart.

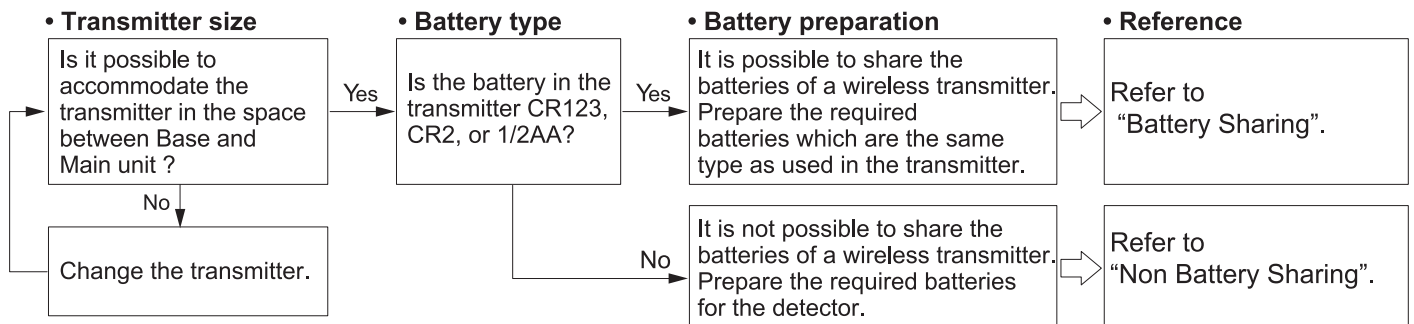

-Battery Sharing

Power supplied is available from battery box to power the detector and the transmitter.

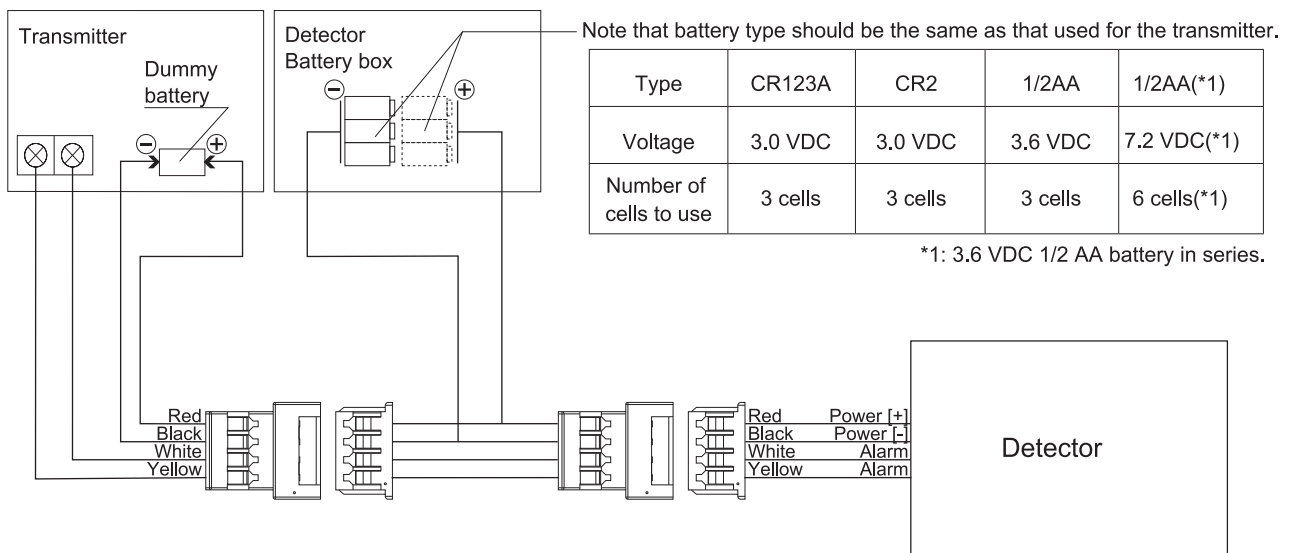

-Non Battery Sharing

Separate batteries for the detector and the transmitter.

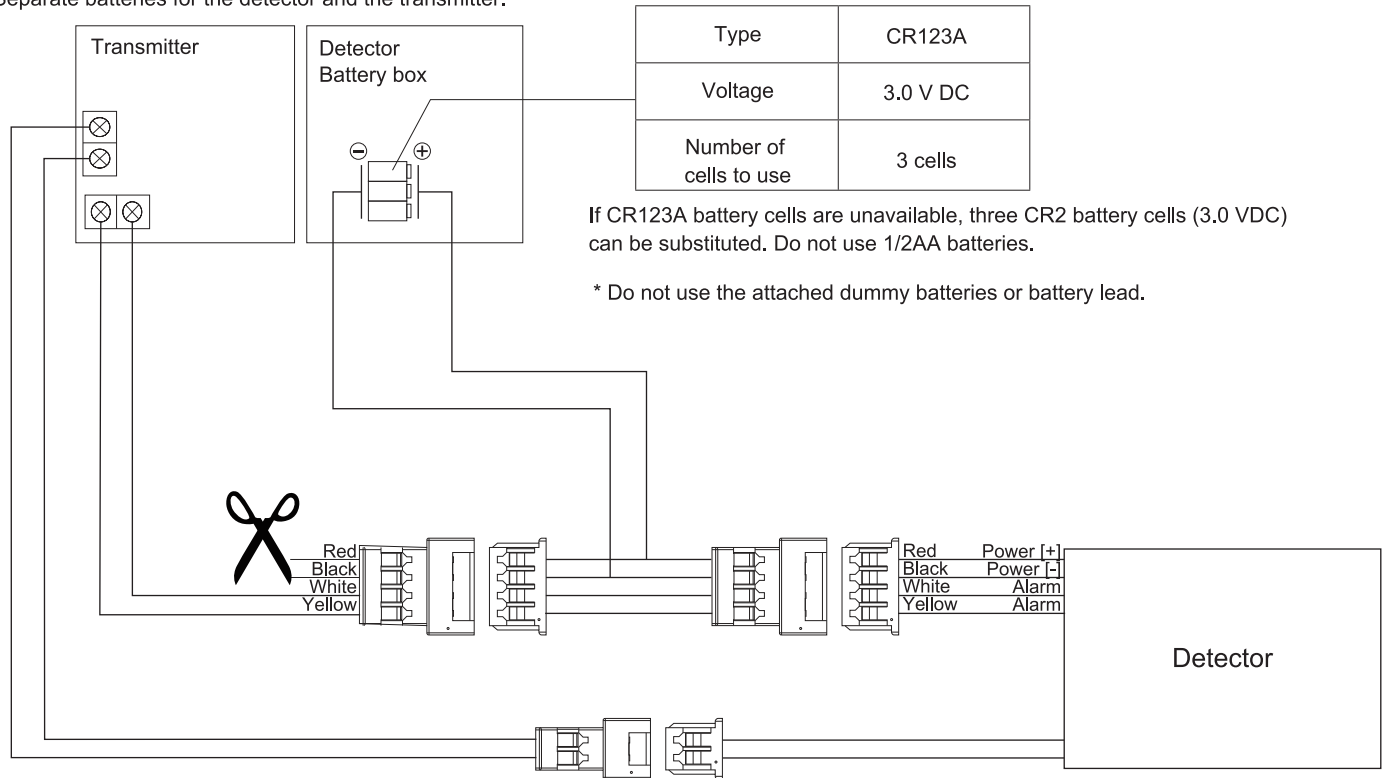

3 Mounting

-Battery Sharing

Warning

Do not use batteries of different residual quantities (i.e.: mixing new and used batteries) or of different manufacturers and/or types together. Not observing the above may result in an explosion, leakage of electrolyte, emission of toxic gases or other outcomes that may be harmful to people and property.

1 Remove the battery box cover.

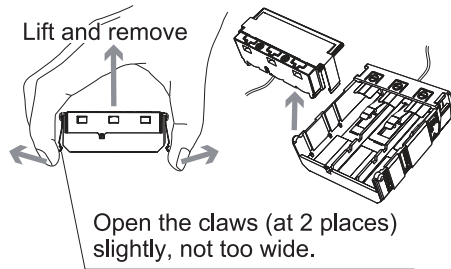

2 Mount batteries and place cover into correct position using indicator on side of battery box.

CR123A×3 (3.0 VDC) CR2×3 (3.0 VDC) 1/2AA×3 (3.6 VDC) 1/2AA×6 (7.2 VDC×3) (*1)

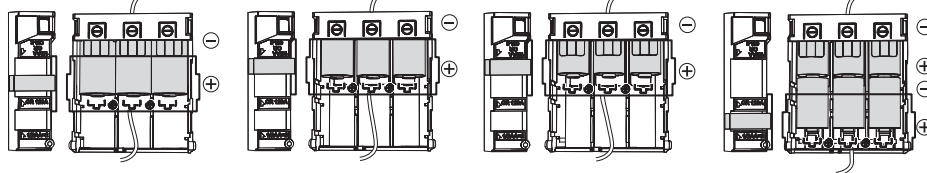

*1: 3.6 VDC 1/2 AA battery in series.

Caution

To avoid short circuit, do not connect ends of red and black wires together.

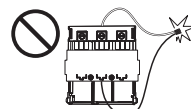

3 Open the transmitter cover and remove the battery.

4 Place the dummy battery in the battery case of the wireless transmitter.

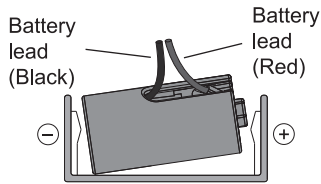

Caution
Do not pull the wire when taking out the dummy battery from the wireless transmitter.

Note>>

- When the dummy battery assemble, do not connect battery leads to power source.
- Make sure that the device is not energized when combining units.

* Refer to followings how to set the dummy battery unit adopting to each battery size.

5 Connect the alarm cable to the transmitter and close the cover.

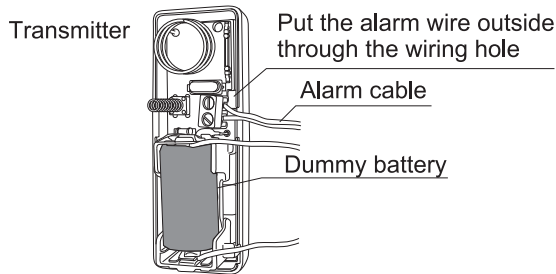

Dummy Battery unit

CR123A For CR123A, use the unit as the factory default setting.

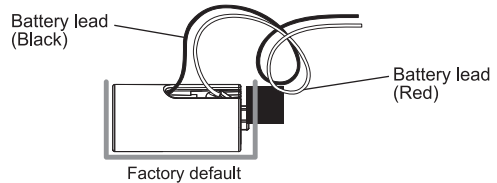

Once disassembled, see the steps below to reassemble the unit.

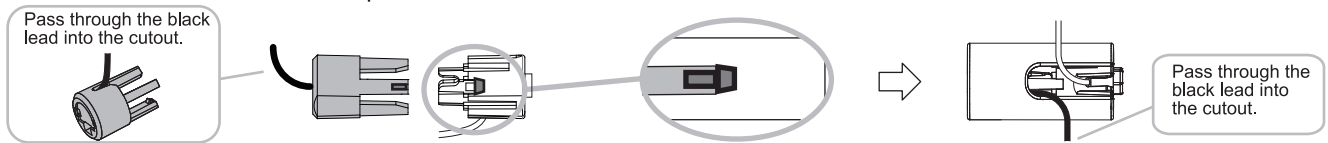

CR2
1/2AA
1/2AA x 2

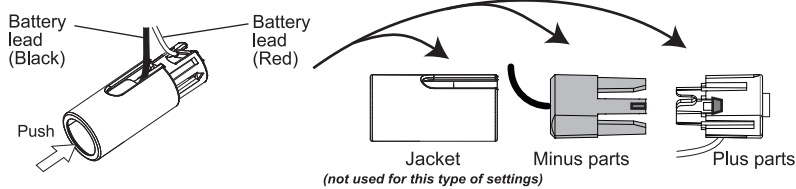

Warning

- Do not touch the ends of the red and black wires to avoid short-circuit.
- Do not pull the wire when taking out the parts from the jacket.

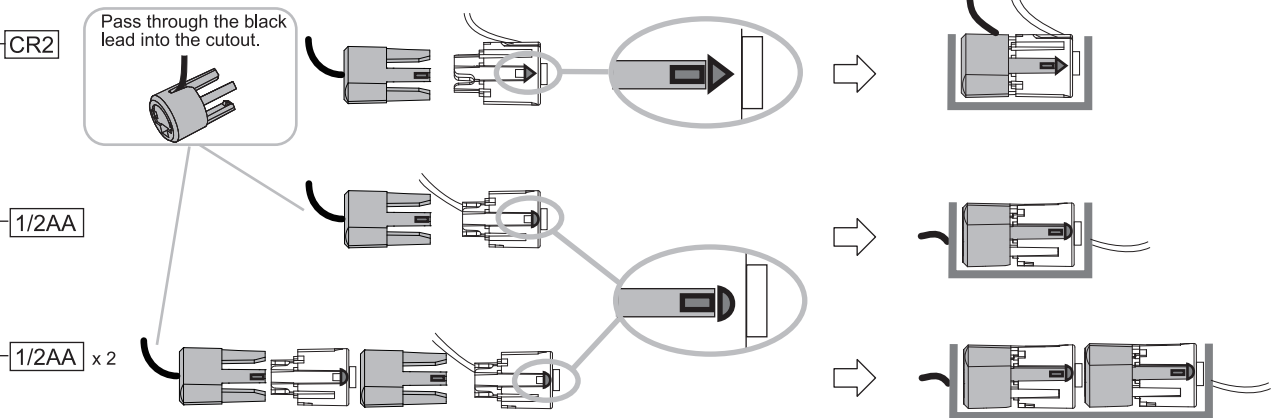

-Non Battery Sharing

Arrange 3 cells each of CR-123A (recommended) or CR2.

- 1 Remove the battery box cover.

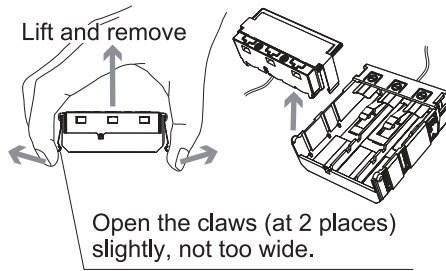

- 2 Mount batteries and place cover into correct position using indicator on side of battery box.

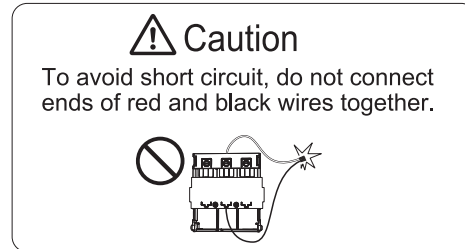
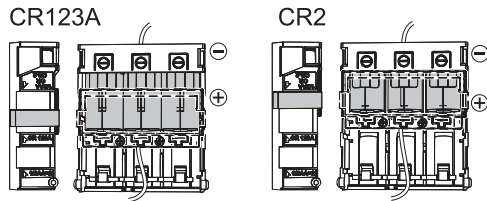

- 3 Connect the alarm cable to the transmitter and close the cover.

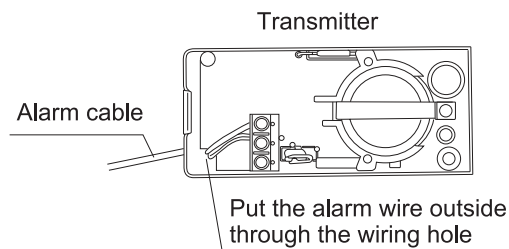

4 Connecting

Joint each connectors to complete installations.

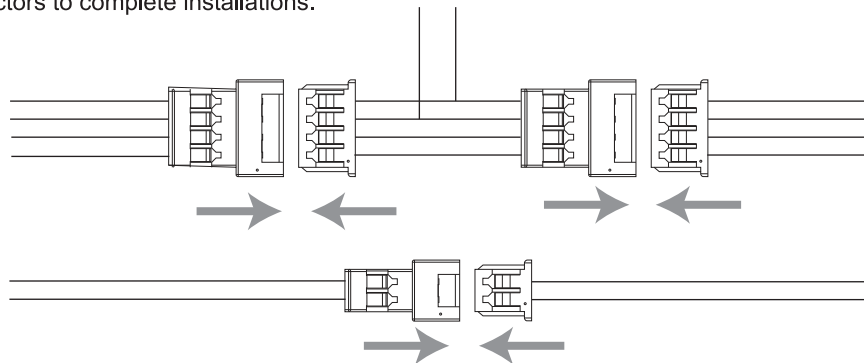

Refer to the installation instructions of each detector for more details.
The installation instructions can be downloaded in; www.optex.net



OPTEX CO., LTD. (JAPAN)
URL: www.optex.net

OPTEX INC. / AMERICAS HQ (U.S.)
URL: www.optexamerica.com

OPTEX SECURITY SAS (France)
URL: www.optex-security.com

OPTEX KOREA CO.,LTD. (Korea)
URL: www.optexkorea.com

OPTEX (EUROPE) LTD. / EMEA HQ (U.K.)
URL: www.optex-europe.com

OPTEX SECURITY Sp.z o.o. (Poland)
URL: www.optex.com.pl

OPTEX (DONGGUAN) CO.,LTD. SHANGHAI OFFICE (China)
URL: www.optexchina.com

OPTEX TECHNOLOGIES B.V. (The Netherlands)
URL: www.optex.eu

OPTEX PINNACLE INDIA, PVT., LTD. (India)
URL: www.optex.net/in/en/sec

OPTEX (Thailand) CO., LTD. (Thailand)
URL: www.optex.net/th/th