



DOGE

LA TECNOLOGIA SI FA ELEGANZA
TECHNOLOGY BECOMES ELEGANT

DOGE



Design elegante e raffinato. Una vasta gamma cromatica per una sirena d'allarme di alta tecnologia capace di assicurare una totale protezione conferendo stile e carattere a tutti i tipi di ambiente.

Elegant design, wide chromatic range for an high-technology alarm sounder able to assure total protection, style and unique personality to all kinds of locations.

PERSONALIZZAZIONI CUSTOMIZATIONS

Supplemento per colore cromo
Extra cost for chromium version

Supplemento per colorazioni personalizzate (min. 50 pz.)
Extra cost for customized colours (50 pcs. min.)



Adesivi (min. 200 pz.) - Decalco (min. 50 pz.)
Embossed stickers (200 pcs. min.) - Decal (50 pcs. min.)

COLORI COLOURS

Coperchio Esterno
External cover

	Bianco perlato Pearly white
	Acciaio Grey
	Champagne Champagne
	Rosso mattone Brick Red
	Bronzo Bronze
	Rame Copper
	Cromo Chromium Colore disponibile con supplemento Colour available at extra cost

Calotte
Flash covers

	Arancio Orange
	Azzurro Light blue
	Fumè Smoke grey

DI SERIE STANDARD FEATURES



ON/OFF positivo e negativo settabile da dip switch
Positive and negative ON/OFF settable by dip switch



Comando di interruzione suono
Command for sound interruption



Controllo batteria secondo normativa EN 50131
Battery control according to EN 50131 standard



Segnalazione ottica e acustica impianto ON/OFF
Optical and acoustic ON/OFF signaling



4 Suoni programmabili e 4 temporizzazioni settabili da dip switch
4 programmable sounds and 4 timings settable by dip switch



Bolla di centratura
Spirit level



DOGE LSP

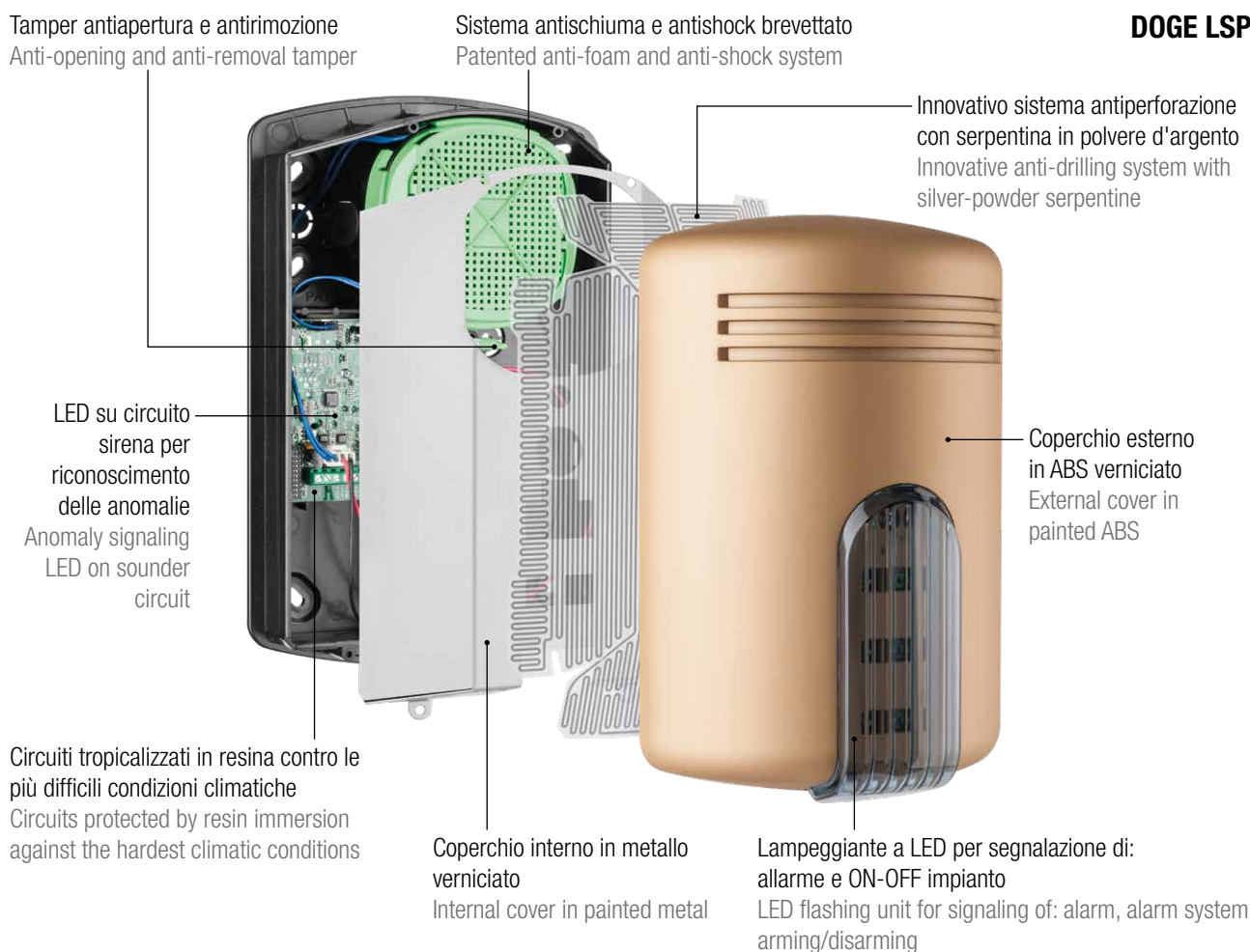

DOGE WIRELESS

Sirena compatibile con qualsiasi tipo di centrale. Il carattere originale di Doge si trasporta anche nella versione wireless, per offrire soluzioni di protezione complete anche nei sistemi più complessi senza intervenire con opere invasive.

The original design of Doge is transferred into its wireless version, which is compatible with any kind of control panels. Venitem offers a complete security solution to adapt itself to the most complex systems without carrying out invasive building works.

MODELLI MODELS

DOGE AS1

Sirena wireless con sistema antischiuma e antishock con pacco batteria TBA 7.5 /
Wireless sounder with anti-foam and anti-shock protection with TBA 7.5 battery pack

DOGE AS1/P

Sirena wireless con sistema antischiuma, antishock e antiperforazione con pacco batteria TBA 7.5 /
Wireless sounder with anti-foam, anti-shock and anti-drilling protection with TBA 7.5 battery pack



DATI TECNICI / TECHNICAL DATA

Alimentazione (pacchetto batterie alcaline size "D") Power supply (alkaline battery pack size "D")	7.5 V
Assorbimento a riposo / Standby consumption	100 microA
Frequenza di trasmissione / Transmitting frequency	433.92 MHz
Frequenza di ricezione / Receiving frequency	433.92 MHz
Segnalazione ottica / Optical signaling	ON/OFF impianto (escludibile) ON/OFF signaler (can be excluded)
Segnalazione acustica / Acoustic signaling	ON/OFF impianto (escludibile) ON/OFF signaler (can be excluded)
Suono / Sound	4 suoni programmabili 4 programmable sounds
Temporizzazione / Timing	4 temporizzazioni programmabili 4 adjustable timings
Potenza sonora a 1 m / Sound level at 1 m	108 dB (A)
Tamper	Doppio reed magnetico (antiapertura e antistrappo) Double magnetic reed (anti-opening and anti-removal)
Portata in spazio aperto / Radio range in open space	100 m
Temperatura di funzionamento / Operating temperature	-25°C ÷ +55°C
Grado di protezione / Protection level	IP 44

ATX2/S

Modulo bidirezionale con sirena interna per comandare fino a 8 sirene Doge wireless.

Two-way radio device with internal sounder able to control up to 8 Doge wireless sounders.

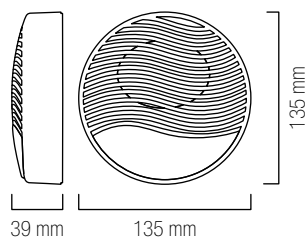

LED anomalia e display sirene memorizzate
Anomaly LEDs and display to visualize memorized sounders



ATX3

Modulo bidirezionale senza sirena interna per comandare fino a 8 sirene Doge wireless.

Two-way radio device able to control up to 8 Doge wireless sounders (without internal sounder).

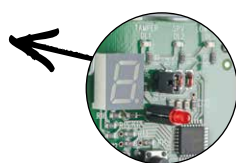

Display sirene memorizzate
Display to visualize memorized sounders

LED generale anomalia / General anomaly LED

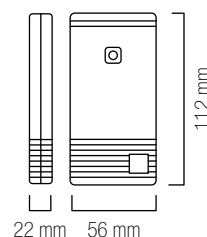

DATI TECNICI / TECHNICAL DATA

	ATX2/S	ATX3
Alimentazione / Power supply	12 Vcc	12 Vcc
Assorbimento a riposo / Standby consumption	100 microA	100 microA
Assorbimento in allarme / Alarm consumption	110 mA MAX	110 mA MAX
Frequenza sirena piezoelettrica / Piezoelectric sounder frequency	2600 Hz ÷ 3600 Hz	—
Frequenza di trasmissione / Transmitting frequency	433.92 MHz	433.92 MHz
Frequenza di ricezione / Receiving frequency	433.92 MHz	433.92 MHz
Temperatura di funzionamento / Operating temperature	+5°C ÷ +40°C	+5°C ÷ +40°C
Grado di protezione / Protection level	IP 3X	IP 4X
Peso (gr.) / Weight (gr.)	161	69.5

**KIT
KITS**

KIT 1 DOGE AS1+ ATX2/S + TBA 7.5

KIT 2 DOGE AS1 + ATX3 + TBA 7.5

KIT 1/P DOGE AS1/P + ATX2/S + TBA 7.5

KIT 2/P DOGE AS1/P + ATX3 + TBA 7.5

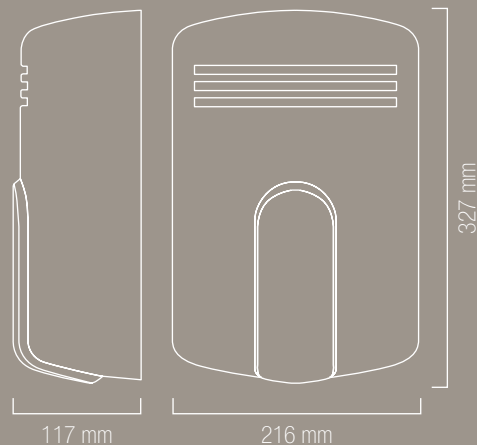

DATI TECNICI / TECHNICAL DATA

	DOGE L	DOGE LS	DOGE LSP
Alimentazione / Power supply: 13.8 Vdc	•	•	•
Assorbimento MAX dalla centrale / MAX consumption from alarm control panel: 800 mA	•	•	•
Assorbimento a riposo / Standby consumption: 15 mA	•	•	•
Assorbimento in allarme dalla batteria / Battery consumption in alarm: 1.4 A	•	•	•
Assorbimento LED / LED consumption: 100 mA	•	•	•
Frequenza fondamentale / Fundamental frequency: 1432 Hz	•	•	•
Potenza sonora MAX a 1 m / MAX level sound at 1 m: dB	114.7	112.6	112.6
Memoria allarme / Alarm memory	•	•	•
Possibilità di comando a 3 o 2 fili / 3 or 2 wires control option	•	•	•
Limite allarmi giornalieri / allarmi infiniti (settabili da dip switch) Max daily alarms / Infinite alarms (settable by dip switch)	•	•	•
Test sirena e batteria comandabile da remoto / Remote test of sounder and battery	•	•	•
Uscita anomalia / Anomaly output	•	•	•
LED interno per individuazione anomalia (su circuito sirena) / Anomaly signaling LED (on sounder board)	•	•	•
Sistema antiapertura e antirimozione a doppio tamper / Anti-opening and anti-removal double-tamper system	•	•	•
Sistema antischiama e antishock brevettato a doppia rilevazione Patented double-detection anti-foam and anti-shock device		•	•
Sistema antiperforazione / Anti-drilling system			•
Grado di sicurezza / Security level	3	3	4
Classe ambientale / Environmental class: IV	•	•	•
Grado protezione / Protection level: IP 44	•	•	•
Temperatura di funzionamento / Operating temperature: -25°C ÷ +55°C	•	•	•
Resistenza all'impatto / Impact resistance: IK 08	•	•	•
Batteria / Battery: 12 V 2.1 Ah Pb o/or 12 V 1.2 Ah Pb	•	•	•
Certificazione di Conformità alla Normativa EN 50131-4 / Complying with EN 50131-4 Standard	•	•	•
Conformità T031 / T031 compliance	•	•	•
Marchio / Marks: IMQ Sistemi di sicurezza	•	•	•
Marchio / Marks: INCERT	•	•	•
Peso (gr.) / Weight (gr.)	2250	2260	2300