

riscogroup.com



EN

IT

FR

ES

CN

EN

SEISMIC DETECTOR



MODEL: RK66S

INSTALLATION INSTRUCTIONS

INTRODUCTION

The RISCO Seismic Detector is used for the protection against break-in attempts of vaults, safes, reinforced concrete walls, steel armored cabinets and doors. The seismic detector monitors the vibration and temperature of a specific surface and will react to all known types of intruder attacks, such as sledge hammers, diamond head drills, explosives, hydraulic pressure tools and thermal tools.

The detector can operate both as a regular relay detector connected to any control panel, or as a BUS accessory when connected to RISCO Group's control panels via the RS485 BUS, empowering it with unique remote control and diagnostic capabilities.

The instructions set forth below describe the RISCO seismic detector in Stand Alone & BUS mode. For BUS installation programming, see RISCO System installation manuals

Main Features:

- Piezo sensor
- Low/High temperature detection
- Detection range up to 5 meters (16 feet) radius
- Tamper protection
- Anti drilling shield
- Remote sensitivity control
- Analogue signal output
- Bar graph LED indicator
- Remote self test
- Stand-alone or RISCO BUS connection

INSTALLATION KIT

Each kit includes:

Wall structure fastening sets:



Expanding plugs M6 x 16
Flat head machining screw M6 X 16

Metallic structure fastening sets:



Inner Tooth Washer M4
Pan Head Machining Screw M4 X 16

External Test Generator

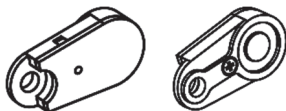

Detector

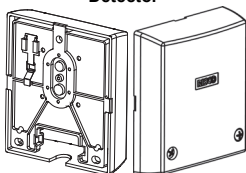

Mounting Plate

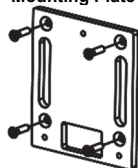

(Mandatory for surfaces like concrete)

PCB LAYOUT

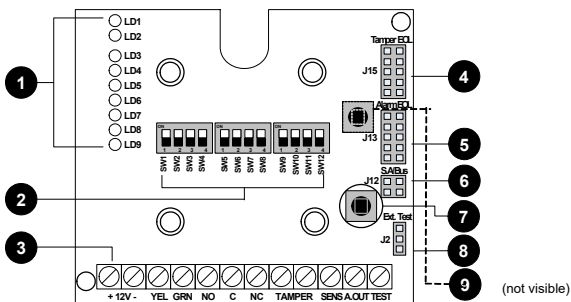

1	Bar Graph LEDs	2	Dipswitches (default state)	3	Terminal Blocks
4	Tamper EOL Jumper	5	Alarm EOL Jumper	6	Stand Alone/BUS Jumper
7	Tamper (Front)	8	External Test Generator Connector	9	Tamper (Back)

MOUNTING THE DETECTOR

- Determine the mounting position. Potential false alarm sources must be accounted for when installing RK66S. Therefore:
- Attach the sensor to a surface as isolated as possible from extraneous vibrations, with close contact between the concrete surface and the detector. For metallic surfaces, remove residual paint from sensor installation site. Do not use silicon grease between sensor and object!
- For maximum vibration detection, the concrete surface should be smooth. Use the mounting plate (see Figure 2) when mounting on drill-resistant steel, brick or concrete surfaces. The plate can also be welded onto metallic surfaces.
- Adjust dipswitch settings for sensitivity; time and other parameters (see Dipswitch settings, below) for background vibration – bearing in mind the inverse relation between detection range and sensitivity and the construction material of the object to be monitored. Detectors with high sensitivity can be spaced up to 5m apart on secure protected surfaces (for example, steel), confirmed by hammer or scratch tests.
- Hinged doors, such as those on safes or ATM, and other attachments without continuous acoustic transmission paths, should be protected with their own detectors.
- Remove the cover fixing screws to separate the cover from the base, see Figure 1(A) / 2(B).
- Drill holes on the mounting surface, using the detector base or mounting plate as a guide, as follows:

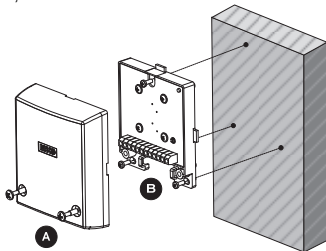

Figure 1: Mounting the detector directly onto a metallic surface

Direct mounting on a metallic surface (Figure. 1)

- a. Ensure that the mounting surface is level to within 1/128" (0.1mm).
- b. Use the detector base as a drilling template for the three holes (3.2 mm dia.) and tap M4 thread at least ¼" (6 mm) deep. Deburr threaded holes in metal.
- c. Fit the detector using the supplied fixing screws, see Figure 1(B).

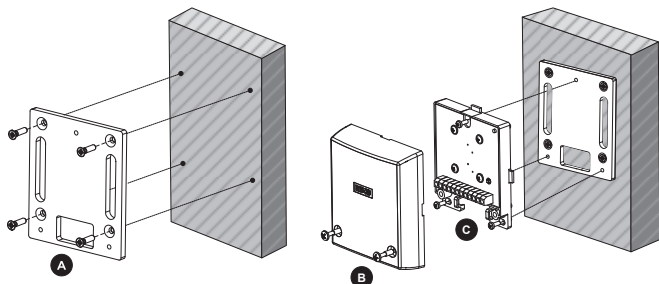

Figure 2: Mounting the detector using the mounting plate. (Note: Affix the mounting plate using fixing screws or optionally, by welding the plate to a metallic surface.)

Installation using mounting plate (Figure 2):

- a. (Optional metal welding) Weld the mounting plate along the two provided vertical oblong cutout surfaces. Tap off slag and remove weld splatter from the plate surface.
- b. (On concrete) :
Never install the detector directly on a bare or plastered concrete surface, since bending forces may cause damage to the seismic sensor. Plaster of less than 10mm need not be removed.
 - i. Drill four holes for mounting plate (8 mm dia, min 35 mm depth for anchor; using a sintered carbide bit.
 - ii. Also, use the mounting plate as a drilling template for the three threaded detector holes (5 mm dia) at least 3 mm deep.
 - iii. Insert supplied metal plugs into drilled hole flush with the concrete surface
 - iv. Ensure that the mounting plate is correctly positioned. Press the mounting plate onto surface, knock in screw with plug and tighten well. The plate should not be capable of rotation.
 - v. Fit the detector using the supplied fixing screws, see Figure 2(C).
- c. (On metal) :
 - i. Use the mounting plate as a drilling template for the four holes (5 mm dia.) and tap M6 thread at least 10 mm deep. Deburr threaded holes in metal.
 - ii. Also, use the mounting plate as a drilling template for the three threaded detector holes (5 mm dia) at least 3 mm deep.
 - iii. Affix the mounting plate with the supplied screws. The plate should not be capable of rotation
 - iv. Fit the detector using the supplied fixing screws, see Figure 2(C).

- Connect wiring; Refer to Terminal Blocks section.
- Set Jumpers; Refer to Jumper Selection section.
- Set Dipswitches; Refer to Dipswitch Settings section.
- To verify detector operation, perform:
 - a. A self test (See Testing the Detector section).
 - b. Sensitivity calibration using an external test generator (See External Test Generator section).
- Replace the cover and tighten the cover fixing screws; See Figure 1(A) / 2(B).

TERMINAL BLOCK LAYOUT



Figure 3: Terminal Block Layout

Terminal Block	Description
+12V (RED)	Power supply positive (+) input voltage
- (BLK)	Power supply negative (-) input voltage
YEL	Used for data communication with RISCO panels (only for BUS connection)
GRN	Used for data communication with RISCO panels (only for BUS connection)
NO	Alarm Normally Opened relay output, 24VDC.0.1A
C	Alarm Common relay output
NC	Alarm Normally Closed relay output, 24VDC.0.1A
TAMPER	N.C. Tamper Switch, 24VDC.0.1A
SENS	Remote sensitivity control for lowering vibration sensitivity for ATM-type dispensers when cash is being disbursed and internal vibration generated. GND = Low sensitivity Not Connected = Regular sensitivity
A.OUT	Analog signal output: Connect a multimeter/scope or an analogic tester between the A.OUT and -12V terminals, to view the noise and signal voltage levels (in parallel to the LED bar representation). In the absence of vibrations, the voltage signal is 0V, and it increases as it detects vibrations. If the voltage measured (in absence of vibrations) doesn't remain stable but continues to increase, it means that environmental noise is being captured and therefore the detector sensitivity must be reduced.
TEST	A short between TEST and GND activates the Remote Test (see Dipswitch Settings 8 and 9). (Not relevant for BUS mode.)

LED DISPLAY DURING NORMAL MODE

LED ON	Color	Severity	Description
LD1	Red		Temperature alarm detection
LD2	Red		Vibration alarm detection: Bar graph (from LED8–2) indicating signal power.
LD3	Yellow		
LD4-8	Green		
LD9	Green		Power On



NOTE:

During Test mode the LED displays have a different meaning. Refer to the section: Testing the detector.

DIPSWITCH SETTINGS

STANDALONE MODE

Dipswitch	Description (SW7 OFF)																											
SW1 SW2 SW3	Used to determine the detector's sensitivity. Sensitivity is a function of coverage area and surface material. <table border="1" data-bbox="259 844 466 1092"> <thead> <tr> <th>SW1</th> <th>SW2</th> <th>SW3</th> </tr> </thead> <tbody> <tr> <td>*OFF</td> <td>*OFF</td> <td>*OFF</td> </tr> <tr> <td>ON</td> <td>OFF</td> <td>OFF</td> </tr> <tr> <td>OFF</td> <td>ON</td> <td>OFF</td> </tr> <tr> <td>ON</td> <td>ON</td> <td>OFF</td> </tr> <tr> <td>OFF</td> <td>OFF</td> <td>ON</td> </tr> <tr> <td>ON</td> <td>OFF</td> <td>ON</td> </tr> <tr> <td>OFF</td> <td>ON</td> <td>ON</td> </tr> <tr> <td>ON</td> <td>ON</td> <td>ON</td> </tr> </tbody> </table> <div style="text-align: center;">  <p>Low Sensitivity</p> <p>High Sensitivity</p> </div>	SW1	SW2	SW3	*OFF	*OFF	*OFF	ON	OFF	OFF	OFF	ON	OFF	ON	ON	OFF	OFF	OFF	ON	ON	OFF	ON	OFF	ON	ON	ON	ON	ON
SW1	SW2	SW3																										
*OFF	*OFF	*OFF																										
ON	OFF	OFF																										
OFF	ON	OFF																										
ON	ON	OFF																										
OFF	OFF	ON																										
ON	OFF	ON																										
OFF	ON	ON																										
ON	ON	ON																										
SW4	Used to detect single and extremely brief and intense signals (including explosions and sledge hammers). ON: Enable *OFF: Disable																											

Dipswitch	Description (SW7 OFF)															
SW5 SW6	<p>Used to adjust the integration time. In combination with SW1-3 they establish a threshold value; SW5-6 establishes a cumulative alarm signal value which, when exceeding the threshold value, triggers an alarm event.</p> <table border="1"> <thead> <tr> <th>SW5</th> <th>SW6</th> <th>Duration (in sec.)</th> </tr> </thead> <tbody> <tr> <td>*OFF</td> <td>*OFF</td> <td>10 (example: vending machine)</td> </tr> <tr> <td>ON</td> <td>OFF</td> <td>26</td> </tr> <tr> <td>OFF</td> <td>ON</td> <td>46</td> </tr> <tr> <td>ON</td> <td>ON</td> <td>80 (example: bank vault)</td> </tr> </tbody> </table>	SW5	SW6	Duration (in sec.)	*OFF	*OFF	10 (example: vending machine)	ON	OFF	26	OFF	ON	46	ON	ON	80 (example: bank vault)
SW5	SW6	Duration (in sec.)														
*OFF	*OFF	10 (example: vending machine)														
ON	OFF	26														
OFF	ON	46														
ON	ON	80 (example: bank vault)														
SW7	<p>Used to determine Stand Alone or BUS mode (Ensure that the J12 position (as below) matches the SW7 spec.) ON: BUS *OFF: Stand Alone</p>															
SW8	<p>Used to determine Local or Remote Test ON: Local. An internal self test is performed every 24 hours from power-up. Test failure lights up the LEDs (see the <i>Testing the Detector</i> section) and the LEDs remain lit until the next self test. *OFF: Remote. A test is activated whenever the TEST input is connected to GND. If the test passes, the alarm relay opens for three seconds.</p>															
SW9	<p>External test generator ON: Enable External Test Generator *OFF: Disable (internal test)</p>															
SW10	<p>Used to enable the temperature sensor (alarm temperature threshold of +85°C (+185°F)) ON: Enable *OFF: Disable (No temp. threshold is set)</p>															
SW11	<p>Used to determine LEDs operation ON: Enable *OFF: Disable</p>															
SW12	Not used															

Low
Sensitivity

 High
Sensitivity



BUS MODE

Dipswitch	Description
SW1-5	BUS Address
SW7	ON: BUS
SW6,8-12	Not Applicable

ID	1	2	3	4	5
01	OFF	OFF	OFF	OFF	OFF
02	ON	OFF	OFF	OFF	OFF
03	OFF	ON	OFF	OFF	OFF
04	ON	ON	OFF	OFF	OFF
05	OFF	OFF	ON	OFF	OFF
06	ON	OFF	ON	OFF	OFF
07	OFF	ON	ON	OFF	OFF
08	ON	ON	ON	OFF	OFF
09	OFF	OFF	OFF	ON	OFF
10	ON	OFF	OFF	ON	OFF
11	OFF	ON	OFF	ON	OFF
12	ON	ON	OFF	ON	OFF
13	OFF	OFF	ON	ON	OFF
14	ON	OFF	ON	ON	OFF
15	OFF	ON	ON	ON	OFF
16	ON	ON	ON	ON	OFF

ID	1	2	3	4	5
17	OFF	OFF	OFF	OFF	ON
18	ON	OFF	OFF	OFF	ON
19	OFF	ON	OFF	OFF	ON
20	ON	ON	OFF	OFF	ON
21	OFF	OFF	ON	OFF	ON
22	ON	OFF	ON	OFF	ON
23	OFF	ON	ON	OFF	ON
24	ON	ON	ON	OFF	ON
25	OFF	OFF	OFF	ON	ON
26	ON	OFF	OFF	ON	ON
27	OFF	ON	OFF	ON	ON
28	ON	ON	OFF	ON	ON
29	OFF	OFF	ON	ON	ON
30	ON	OFF	ON	ON	ON
31	OFF	ON	ON	ON	ON
32	ON	ON	ON	ON	ON

JUMPER SELECTION

Jumper	Function
S.A (Stand Alone) /BUS J12	Used to enable tamper indication during Stand Alone or BUS mode.
	 Stand Alone mode (Default).
	 BUS connection mode. (See RISCO system programming manuals).
J13: Alarm EOL J15: Tamper EOL	Jumpers J13 and J15 allow for the selection of Alarm and Tamper resistance (1K, 2.2K, 4.7K, 5.6K and 6.8K) according to the control panel. Follow the terminal block connection diagram in Figure 4 when connecting the detector to a Double End Of Line (DEOL) zone.

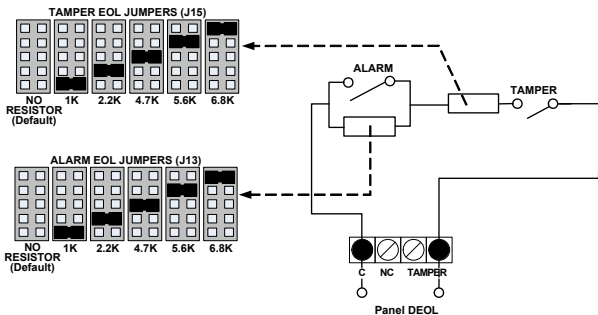

Figure 4: Schematic of EOL Resistors

TESTING THE DETECTOR

RISCO recommends performing a self test after installation and before final cover mounting. The test can be performed manually (locally or remotely) or automatically every 24 hours

Remote self-test (Manual Test)

This test requires that a command be given in order to be performed.

To activate the remote self-test:

- Ensure that the Dipswitch SW8 is set to OFF.
- Short the TEST terminal block to GND.
- All LEDs will turn on to indicate test commencement and sequentially turn off after each successful parameter test.

The detector unit self test examines the following parameters:

LED	Trouble
1	External power supply failure
2	Internal voltage faulty
4	Piezo sensor failure
5	Temperature sensor failure
3, 6-9	Not Applicable

All LEDs will turn off at the end of a successful test, except the POWER LED (LED9) and the alarm relay opens for three seconds. If a malfunction occurs, one of the LEDs remains lit.

Local self-test (Automatic Test)

Ensure that the Dipswitch SW8 is set to ON.

The RK66S detector runs a local/automatic SELF-TEST every 24 hours from the time of initial power on. Test procedure and result presentation is as per the Remote self-test above.

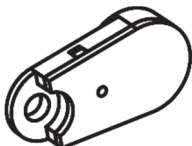

Front view

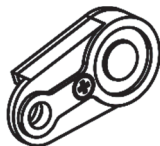

Rear view

Attach to the concrete surface, using the supplied mounting screw in this hole opening.

The external test generator can be used to:

- ◆ Periodically verify proper functioning of the detector
- ◆ Observe the detector's sensitivity during installation

To use the test generator:

- Connect the test generator to J2 on the PC board (with the polarity resulting from the red wire connected to the plug pin closest to the terminal block, in other words, the lowest)
- Switch SW9 to ON.
- Attach the test generator to the concrete surface.
- Perform test, as follows:
 - a. For remote test, see the DIPSWITCH Settings section
 - b. For calibration test, Switch SW8 to ON and observe the LEDs

Specifications

Coverage	Up to 5 meters (16 feet) radius
Operating voltage	9 to 16 VDC
Current consumption	Typically 20mA @ 12VDC
RFI immunity	According to EN50130-4
Alarm contacts	24VDC, 0.1A, N/C and N/O
Tamper contacts	24VDC, 0.1A
Alarm contact hold time	2.5 seconds
Operating temperature	-40°C to +70°C (-40°F to 158°F)
Storage temperature	-50°C to +70°C (-58°F to 158°F)
Ingress protection (IP) rating	IP43
Impact Rating	IK08
RFI immunity	According to EN50130-4
Dimensions (L x H x W)	102 X 27.5 X 80.2 mm (4.0" X 1.1" X 3.2")
Weight	220 g (7.7 oz)

In order to continue improving the product, RISCO Group reserves the right to change specifications and/or designs without prior notice.

Ordering Information

Model	Description
RK66S	Seismic Detector

NOTES

IT

MICROFONO SELETTIVO



MODELLO: RK66S
ISTRUZIONI DI INSTALLAZIONE

INTRODUZIONE

Il microfono selettivo di RISCO è utilizzato per la protezione di caveau, casseforti, mura di cemento armato, armadi e porte blindate. Il microfono selettivo rileva la vibrazione e la temperatura di una specifica superficie e reagisce a tutte le tipologie di attacco conosciute come ad esempio punte di diamante, esplosivi, colpi di mazza, lancia termica e dispositivi idraulici di pressione.

Il rivelatore può funzionare sia tramite connessione a relè ad una qualsiasi centrale antifurto o tramite connessione BUS RS485 con le centrali antifurto RISCO. In quest'ultimo caso il microfono selettivo può essere configurato e testato tramite tastiera del sistema o tramite PC.

Le istruzioni che seguono descrivono il microfono selettivo RISCO sia nella modalità a Relè che in quella BUS. Per il collegamento via BUS far riferimento anche al manuale di installazione della centrale RISCO utilizzata.

Caratteristiche principali

- Sensore piezoelettrico
- Rilevazione temperatura Bassa/Alta
- Portata fino a 2.5 metri di raggio
- Protezione tamper
- Schermo anti-perforazione
- Controllo remoto della sensibilità
- Uscita segnale analogico
- Indicatore grafico a LED
- Auto-test remoto
- Collegamento a relè o via BUS RISCO

KIT DI INSTALLAZIONE

Ogni kit include:

Set di fissaggio comprendente:



Tasselli per viti M6 x 16
Viti a testa piatta tipo M6 X 16

Set metallico di fissaggio comprendente:



Rondella dentata per viti M4
Viti per metallo a testa cilindrica
tipo M4 X 10

Dispositivo esterno di test

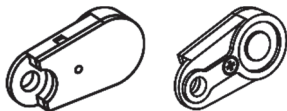

Rivelatore

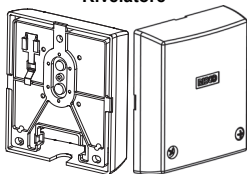

Piastra di fissaggio

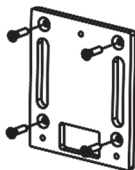

(Obbligatoria per l'installazione su superfici in cemento armato)

DESCRIZIONE DELLA SCHEDA

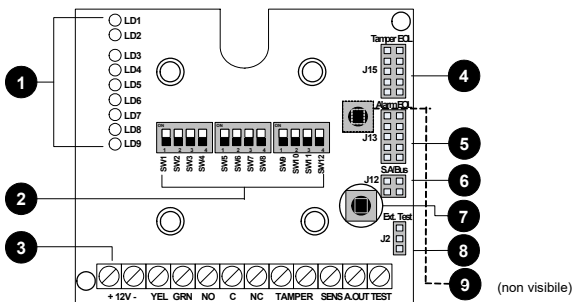

1	Indicatori LED	2	Microinterruttori (default)	3	Morsettiera
4	Ponticello Tamper EOL	5	Ponticello Allarme EOL	6	Ponticello Relè/BUS
7	Tamper (Apertura)	8	Connettore Test esterno	9	Tamper (Rimozione)

INSTALLAZIONE DEL RIVELATORE

- Scegliere la posizione di installazione del microfono selettivo RK66S e tener conto dei potenziali falsi allarmi per cui:
- Posizionare il dispositivo su di una superficie quanto più immune possibile a vibrazioni estranee e quanto più vicino possibile alla superficie da proteggere se quest'ultima è in cemento armato. Per l'installazione su superfici metalliche rimuovere da queste ultime eventuali residui di vernice. Non usare assolutamente pasta di silicone tra il sensore e la superficie di installazione.
- Per ottenere la migliore rilevazione di vibrazione possibile, le superfici di installazione devono essere lisce. Utilizzare la piastra di montaggio (vedere la Figura 2) quando si effettua l'installazione su di una superficie di mattoni, calcestruzzo o su di una superficie metallica resistente al trapano. La piastra di fissaggio può anche essere saldata sulle superfici metalliche.
- Regolare tramite i microinterruttori la sensibilità, il tempo di intervento e gli altri parametri (vedere la sezione Predisposizione dei microinterruttori). Ricordare la relazione tra la sensibilità ed il materiale componente la superficie da proteggere considerando che i microfoni configurati per un'alta sensibilità possono essere distanziati fino a 5 metri dalla superficie da proteggere (ad esempio quando la superficie dell'oggetto è di metallo) la cui verifica può essere effettuata con l'utilizzo di un martello o sfregando la superficie stessa.
- Regolare tramite i microinterruttori la sensibilità, il tempo di intervento e gli altri parametri (vedere la sezione Predisposizione dei microinterruttori). Ricordare la relazione tra la sensibilità ed il materiale componente la superficie da proteggere considerando che i microfoni configurati per un'alta sensibilità possono essere distanziati fino a 5 metri dalla superficie da proteggere (ad esempio quando la superficie dell'oggetto è di metallo) la cui verifica può essere effettuata con l'utilizzo di un martello o sfregando la superficie stessa.
- Rimuovere le viti di fissaggio del coperchio per separare quest'ultimo dalla base, vedere la Figura 1(A) / 2(B).
- Forare la superficie di installazione usando la base del sensore o la piastra di fissaggio come dima. Procedere come segue:



Figura 1: Installazione del microfono selettivo direttamente su di una superficie metallica

Installazione diretta su di una superficie metallica (Figura. 1)

- a. Assicurarsi che la superficie di fissaggio sia in piano entro 0.1mm.
- b. Usare la base del sensore come dima per fare tre fori (da 3.2 mm dia.) e profondi almeno 6 mm per le viti M4. Eliminare le eventuali sbavature provocate dalla foratura del metallo.
- c. Fissare il microfono selettivo utilizzando le viti fornite, vedere la Figura 1(B).

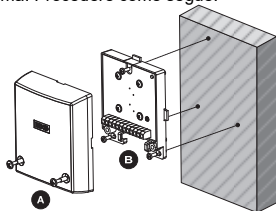

Figura 2: Installazione del microfono selettivo utilizzando la piastra di fissaggio.
(Nota: Fissare la piastra utilizzando le viti di fissaggio o, opzionalmente, saldando la piastra se la superficie da proteggere è metallica).

Installazione utilizzando la piastra di fissaggio (Figura 2):

- d. (Saldatura sul metallo) Saldare la piastra di montaggio lungo le due aperture verticali alla superficie da proteggere. Rimuovere dalla superficie della piastra le sbavature di stagno e gli eventuali detriti.
- e. (Installazione sul calcestruzzo) :
Non installare mai il microfono selettivo direttamente sul cemento a vista o intonacato poiché le eventuali flessioni della superficie possono danneggiare l'unità. L'intonaco minore di 10mm non deve essere rimosso.
 - i. Realizzare 4 fori per la piastra di fissaggio (8 mm dia., min. 35 mm di profondità per tassello) usando una punta specifica per il calcestruzzo.
 - ii. Usare la piastra di fissaggio come dima per realizzare i 3 fori da 5 mm di diametro e almeno 3 mm di profondità per il fissaggio del sensore sulla piastra.
 - iii. Inserire i tasselli in metallo in dotazione a filo con la superficie del calcestruzzo.

- iv. Assicurarsi che la piastra di installazione sia posizionata correttamente. Spingere la piastra contro la parete, , spingere le viti con il tassello e stringerle bene. La piastra non deve avere alcuna possibilità di movimento.
- v. Fissare il rivelatore utilizzando le viti fornite, vedere la Figura 2(C).
- f. (Installazione sul metallo) :
 - i. Usare la piastra di fissaggio come dima per realizzare i 3 fori da 5 mm di diametro e almeno 10 mm di profondità per le viti M6. Eliminare le eventuali sbavature provocate dalla foratura del metallo.
 - ii. Usare ancora la piastra di fissaggio come dima per realizzare i 3 fori da 5 mm di diametro e almeno 3 mm di profondità per il fissaggio del sensore sulla piastra.
 - iii. Fissare la piastra di montaggio con le viti fornite. La piastra non deve avere alcuna possibilità di movimento.
 - iv. Fissare il rivelatore utilizzando le viti fornite, vedere la Figura 2(C).
- Cablaggio; far riferimento alla sezione Morsettiera.
- Impostare i ponticelli; far riferimento alla sezione Predisposizione dei ponticelli.
- Impostare i microinterruttori; far riferimento alla sezione Predisposizione microinterruttori.
- Per verificare il funzionamento del microfono selettivo procedere come segue:
 - a. Auto-test (Vedere la sezione Test del rivelatore).
 - b. Calibrazione della sensibilità tramite dispositivo di test esterno (Vedere la sezione Dispositivo esterno di test).
- Riposizionare il coperchio e stringere le viti di fissaggio, vedere la Figura 1(A) / 2(B).

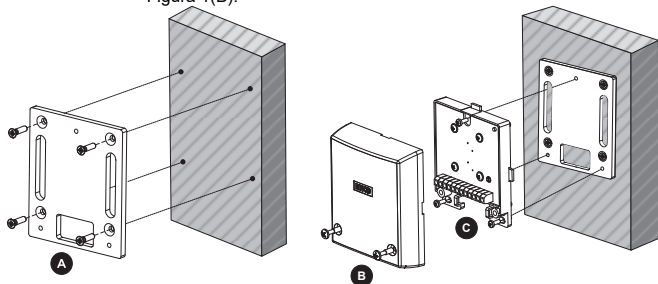
MORSETTIERA



Figura 3: Morsetti

Morsetti	Descrizione
+12V (RED)	Ingresso positivo di alimentazione (+)
- (BLK)	Ingresso negativo di alimentazione (-)
YEL	Usato per la comunicazione via BUS con le centrali RISCO
GRN	Usato per la comunicazione via BUS con le centrali RISCO
NO	Uscita a relè normalmente aperta, 24Vcc. 0.1A
C	Riferimento comune del relè
NC	Uscita a relè normalmente chiusa, 24VDC.0.1A
TAMPER	Uscita Tamper N.C. , 24Vcc. 0.1A
SENS	Controllo remoto della sensibilità (usato per diminuire la sensibilità per i Bancomat che, quando erogano il denaro contante, generano una vibrazione interna). GND = Bassa sensibilità Non collegato = sensibilità Regular
A.OUT	Uscita segnale analogico: usato per connettere un multimetro o un tester analogico tra questo morsetto A.OUT e il morsetto -12V, tramite il quale rilevare i valori di rumore e di segnale (valori riportati anche tramite la scala LED) . In assenza di vibrazioni il livello di segnale deve essere 0 Volt e aumentare se rileva vibrazioni.
TEST	Applicare un negativo (0V) a questo ingresso quando si richiede una sensibilità minore, in caso contrario applicare una tensione (+12V) o lasciare l'ingresso non connesso.

DISPLAY LED NEL NORMALE FUNZIONAMENTO

LED ON	Colore	Gravità	Descrizione
LD1	Rosso		Rilevazione allarme temperatura
LD2	Rosso		Rilevazione allarme vibrazione: La scala LED (LED da 8 a 2) indicano il livello di segnale.
LD3	Giallo		
LD4-8	Verde		
LD9	Verde		Alimentazione





NOTA:

Nella modalità Test il display a LED ha una funzione differente. Fare riferimento alla sezione: Test del microfono selettivo.

PREDISPOSIZIONE MICROINTERRUTTORI

Modalità a Relè

Micrint.	Descrizione (SW7 OFF)																																				
SW1 SW2 SW3	<p>Usato per impostare la sensibilità del rivelatore. La sensibilità dipende dall'area e al materiale della superficie ove è fissato il rivelatore.</p> <table border="1" data-bbox="246 870 446 1112"> <thead> <tr> <th>SW1</th> <th>SW2</th> <th>SW3</th> <th></th> </tr> </thead> <tbody> <tr> <td>*OFF</td> <td>*OFF</td> <td>*OFF</td> <td></td> </tr> <tr> <td>ON</td> <td>OFF</td> <td>OFF</td> <td></td> </tr> <tr> <td>OFF</td> <td>ON</td> <td>OFF</td> <td></td> </tr> <tr> <td>ON</td> <td>ON</td> <td>OFF</td> <td></td> </tr> <tr> <td>OFF</td> <td>OFF</td> <td>ON</td> <td></td> </tr> <tr> <td>ON</td> <td>OFF</td> <td>ON</td> <td></td> </tr> <tr> <td>OFF</td> <td>ON</td> <td>ON</td> <td></td> </tr> <tr> <td>ON</td> <td>ON</td> <td>ON</td> <td></td> </tr> </tbody> </table> <div style="text-align: center;"> <p>Bassa sensibilità</p>  <p>Alta sensibilità</p> </div>	SW1	SW2	SW3		*OFF	*OFF	*OFF		ON	OFF	OFF		OFF	ON	OFF		ON	ON	OFF		OFF	OFF	ON		ON	OFF	ON		OFF	ON	ON		ON	ON	ON	
SW1	SW2	SW3																																			
*OFF	*OFF	*OFF																																			
ON	OFF	OFF																																			
OFF	ON	OFF																																			
ON	ON	OFF																																			
OFF	OFF	ON																																			
ON	OFF	ON																																			
OFF	ON	ON																																			
ON	ON	ON																																			
SW4	<p>Usato per rilevare segnali estremamente corti ed intensi (incluso esplosioni e colpi di mazza). ON: Abilitato *OFF: Disabilitato</p>																																				

Microint.	Descrizione (SW7 OFF)															
SW5 SW6	<p>Questi microinterruttori vengono usati per regolare il tempo di integrazione.</p> <p>Mentre i microinterruttori SW1-3 stabiliscono una soglia di allarme, SW5-6 definiscono la persistenza del segnale che, se supera la soglia definita, attiva l'evento di allarme</p> <table border="1"> <thead> <tr> <th>SW5</th> <th>SW6</th> <th>Durata (in sec.)</th> </tr> </thead> <tbody> <tr> <td>*OFF</td> <td>*OFF</td> <td>10 (es.: distributore automatico)</td> </tr> <tr> <td>ON</td> <td>OFF</td> <td>26</td> </tr> <tr> <td>OFF</td> <td>ON</td> <td>46</td> </tr> <tr> <td>ON</td> <td>ON</td> <td>80 (es.: caveau della banca)</td> </tr> </tbody> </table>	SW5	SW6	Durata (in sec.)	*OFF	*OFF	10 (es.: distributore automatico)	ON	OFF	26	OFF	ON	46	ON	ON	80 (es.: caveau della banca)
SW5	SW6	Durata (in sec.)														
*OFF	*OFF	10 (es.: distributore automatico)														
ON	OFF	26														
OFF	ON	46														
ON	ON	80 (es.: caveau della banca)														
	<p>Bassa sensibilità</p>  <p>Alta sensibilità</p>															
SW7	<p>Utilizzato per selezionare la modalità di funzionamento a Relè o BUS (Verificare che il ponticello J12 riportato in seguito sia nella corretta posizione per la modalità scelta)</p> <p>ON: BUS</p> <p>*OFF: Relè</p>															
SW8	<p>Utilizzato per l'auto test interno locale o remoto.</p> <p>ON: Locale. Ogni 24 ore viene eseguito un test automatico interno a partire dalla prima alimentazione del sensore. Se il test fallisce vengono accesi i LED (vedere la sezione Test del rivelatore) che rimangono attivi fino al test successivo.</p> <p>*OFF: Remoto. L'auto test del sensore viene effettuato quando al morsetto TEST viene applicato un riferimento negativo di alimentazione GND. Se il test non rileva nessun problema, il relè di allarme si attiva per tre secondi.</p>															
SW9	<p>Dispositivo esterno di test (vedere pagina 13)</p> <p>ON: Dispositivo esterno di test abilitato</p> <p>*OFF: Dispositivo esterno di test disabilitato (test interno)</p>															
SW10	<p>Usato per abilitare il sensore di temperatura (soglia temperatura di allarme +85°C)</p> <p>ON: Abilitato</p> <p>*OFF: Disabilitato (Nessuna impostazione di soglia temperatura)</p>															
SW11	<p>Configura il funzionamento dei LED</p> <p>ON: Abilitati</p> <p>*OFF: Disabilitati</p>															
SW12	Non usato															

* Default



Modalità BUS

Micrint.	Descrizione
SW1-5	Indirizzo ID BUS
SW7	ON: BUS
SW6,8-12	Non Applicabile

ID	1	2	3	4	5
01	OFF	OFF	OFF	OFF	OFF
02	ON	OFF	OFF	OFF	OFF
03	OFF	ON	OFF	OFF	OFF
04	ON	ON	OFF	OFF	OFF
05	OFF	OFF	ON	OFF	OFF
06	ON	OFF	ON	OFF	OFF
07	OFF	ON	ON	OFF	OFF
08	ON	ON	ON	OFF	OFF
09	OFF	OFF	OFF	ON	OFF
10	ON	OFF	OFF	ON	OFF
11	OFF	ON	OFF	ON	OFF
12	ON	ON	OFF	ON	OFF
13	OFF	OFF	ON	ON	OFF
14	ON	OFF	ON	ON	OFF
15	OFF	ON	ON	ON	OFF
16	ON	ON	ON	ON	OFF

ID	1	2	3	4	5
17	OFF	OFF	OFF	OFF	ON
18	ON	OFF	OFF	OFF	ON
19	OFF	ON	OFF	OFF	ON
20	ON	ON	OFF	OFF	ON
21	OFF	OFF	ON	OFF	ON
22	ON	OFF	ON	OFF	ON
23	OFF	ON	ON	OFF	ON
24	ON	ON	ON	OFF	ON
25	OFF	OFF	OFF	ON	ON
26	ON	OFF	OFF	ON	ON
27	OFF	ON	OFF	ON	ON
28	ON	ON	OFF	ON	ON
29	OFF	OFF	ON	ON	ON
30	ON	OFF	ON	ON	ON
31	OFF	ON	ON	ON	ON
32	ON	ON	ON	ON	ON

PREDISPOSIZIONE PONTICELLI

Ponticello	Funzione
S.A (Relè) / BUS J12	Usato per gestire la segnalazione di tamper nelle modalità BUS e Relè.
	 Modalità Relè (Default)
	 Modalità BUS. (Vedere i manuali di programmazione dei sistemi RISCO)
J13: EOL Allarme J15: EOL Tamper	I ponticelli J13 e J15 configurano il valore resistivo delle uscite di allarme e tamper (1K, 2.2K, 4.7K, 5.6K e 6.8K) in riferimento alla centrale utilizzata. Seguire lo schema di collegamento della Figura 4 per collegare il rivelatore ad una zona in doppio bilanciamento resistivo (DEOL).



Figura 4: Schema resistenze EOL

IMQ Nota: l'uso di un contatto di allarme N / O annulla la certificazione IMQA.

AUTO TEST DEL RIVELATORE

RISCO consiglia di effettuare un test interno dopo l'installazione, prima del montaggio definitivo del coperchio. Il test può essere effettuato manualmente (localmente o in remoto) o automaticamente ogni 24 ore.

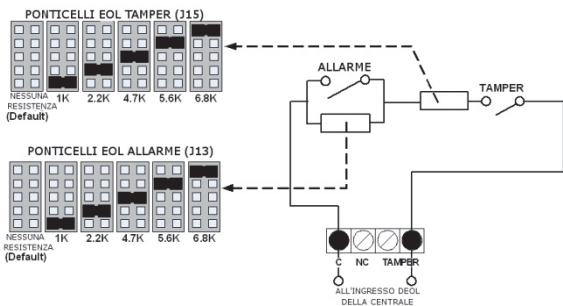
Auto test remoto (Test manuale)

Questo test richiede un comando di attivazione per essere eseguito.

Per attivare l'auto test remoto procedere come segue:

- Controllare che il microinterruttore SW8 sia in OFF.
- Cortocircuitare il morsetto TEST con il GND.
- Tutti i LED si illumineranno evidenziando l'inizio del test e in sequenza si spegneranno dopo che ogni parametro a cui fanno riferimento è stato verificato correttamente funzionante.

L'auto test è in grado di rilevare le eventuali anomalie seguenti:

LED	Anomalia
1	Guasto alimentazione esterna
2	Guasto di alimentazione interno
4	Guasto sensore piezo
5	Guasto sensore di temperatura
3, 6-9	Non usati

Dopo che il test non ha evidenziato guasti, tutti i LED si spegneranno tranne il LED POWER (LED 9) di alimentazione. A conferma del buon esito del test il relè di allarme si aprirà per tre secondi.

Auto Test locale (Test automatico)

Controllare che il microinterruttore SW8 sia in ON.

Il microfono selettivo RK66S avvia un auto test locale/automatico ogni 24 ore a partire dall'alimentazione iniziale. La procedura di test e la rappresentazione e del risultato è la stessa dell'auto test remoto come descritto nel paragrafo precedente Auto Test Remoto (Test manuale).

Dispositivo esterno di test

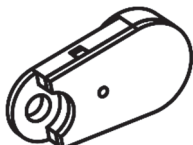

Vista frontale

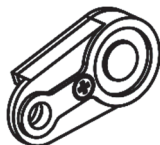

Vista posteriore

Fissare il dispositivo sulla superficie di calcestruzzo utilizzando la vite fornita per l'apposito foro illustrato nell'immagine sopra.

Il dispositivo esterno di test può essere usato per:

- ◆ Verificare periodicamente la corretta rilevazione del microfono
- ◆ Verificare la sensibilità nella fase di installazione

Come utilizzare il dispositivo di test:

- Connettere il dispositivo di test al connettore J2 posizionato sulla scheda elettronica (posizionare il filo rosso nella parte bassa del connettore, quella vicino alla morsettiera)
- Impostare il microinterruttore SW9 su ON.
- Fissare il dispositivo di test alla superficie da proteggere.
- Effettuare il test come segue:
 - a. Per il test remoto fare riferimento alla sezione Predisposizione microinterruttori
 - b. Per il test di calibrazione posizionare il microinterruttore SW8 in ON e osservare il comportamento dei LED.

Specifiche tecniche

Copertura	Fino a 2.5 metri di raggio
Tensione operativa	Da 9 a 16 Vcc
Assorbimento di corrente	20mA @ 12Vcc
Immunità RFI	Conforme alla EN50130-4
Contatti di allarme	24Vcc, 0.1A, N/C e N/O
Contatti Tamper	24Vcc, 0.1A
Tempo di ritenuta dei contatti	2.5 secondi
Temperatura di funzionamento	Da +5°C a +40°C
Temperatura di stoccaggio	Da -50°C to +70°C
Grado di protezione IP	IP43
Grado di protezione contro l'impatto	IK08
Dimensioni (L x H x W)	102 X 27.5 X 80.2 mm
Peso	220 g
Approvazione	Livello II (CEI 79-2)



Informazioni per l'ordinazione

Modello	Descrizione
RK66S	Microfono selettivo

NOTES

FR

DETECTEUR SISMIQUE



MODELE: RK66S
MANUEL D'INSTALLATION

INTRODUCTION

Le détecteur sismique RISCO est utilisé pour la protection contre les tentatives d'effraction des salles fortes, coffre-fort, murs en béton armé, armoires en acier et portes blindées. Le détecteur sismique surveille la vibration et la température d'une surface spécifique et va réagir à tous les types connus d'attaques d'intrusion, comme des marteaux, perceuses à tête de diamant, explosifs, outils de pression hydraulique et outils thermiques.

Le détecteur peut fonctionner à la fois comme un détecteur à relais standard connecté à une centrale d'alarme, ou comme un accessoire BUS lorsqu'il est connecté aux centrales de RISCO Group via le bus RS485, lui apportant un contrôle à distance unique et des capacités de diagnostic.

Les instructions énoncées ci-dessous décrivent le détecteur sismique RISCO en mode Autonome & en mode BUS. Pour la programmation de l'installation BUS, veuillez consulter les manuels d'installation du système RISCO.

Caractéristiques principales:

- Capteur piézo-électrique
- Détection de la température basse / haute
- Portée de détection jusqu'à 5 mètres de rayon
- Protection contre les sabotages
- Bouclier anti-perçage
- Contrôle de la sensibilité à distance
- Signal de sortie analogique
- Indicateur graphique à barres LED
- Autotest à distance
- Autonome ou RISCO connexion BUS

KIT d'INSTALLATION

Chaque kit comprend:

Ensemble de fixation sur support mural:



Chevilles expansibles M6 x 16
Vis à tête plate pour visseuse M6 X 16

Ensemble de fixation sur support métallique:



Rondelle dentelée M4
Vis pour visseuse M4 X 10

Générateur de Test Externe

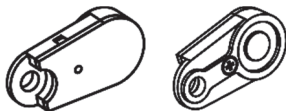

Détecteur

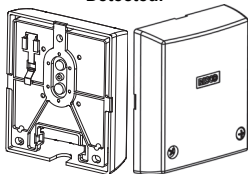

Plaque de Montage

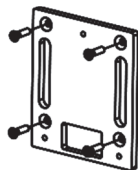

(Obligatoire pour les surfaces comme le béton)

DISPOSITION CARTE

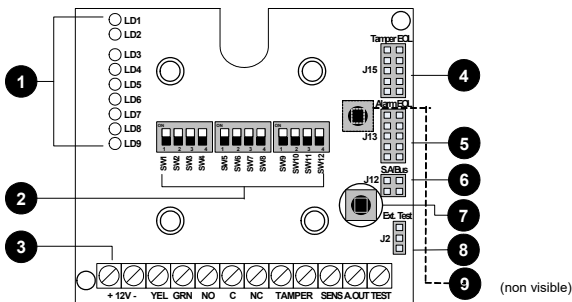

(non visible)

1	Bar Graphe à LEDs	2	Dip switches (position par défaut)	3	Bornier de raccordement
4	Cavaliers EOL Autoprotection	5	Cavaliers EOL Alarme	6	Cavaliers Autonome/BUS
7	Autoprotection (Ouverture)	8	Connecteur du générateur de test externe	9	Autoprotection (Arrachement)

MONTAGE DU DETECTEUR

- Déterminer la position de montage. Les sources de fausses alarmes potentielles doivent être prises en compte lors de l'installation RK66S, donc:
- Fixer le capteur sur une surface aussi isolée que possible des vibrations parasites, en assurant un contact étroit entre la surface du béton et le détecteur. Pour les surfaces métalliques, enlever les restes de peinture sous la surface du capteur. Ne pas utiliser de graisse silicone entre le capteur et l'objet !
- Pour une détection maximale des vibrations, la surface en béton doit être lisse. Utilisez la plaque de montage (voir la figure 2) lors du montage des surfaces en acier résistante au perçage, en brique ou en béton. La plaque peut également être soudée sur des surfaces métalliques.
- Ajuster les paramètres des commutateurs DIP comme la sensibilité; les temporisations et autres paramètres (voir réglages des commutateurs DIP, ci-dessous) pour les vibrations arrière - en gardant à l'esprit la relation inverse entre la zone de détection et la sensibilité et le matériau de construction de l'objet à surveiller. Les détecteurs en haute sensibilité peuvent être espacés jusqu'à 5m sur les surfaces protégées sécurisés (par exemple, acier), confirmé par des tests au marteau ou grattage.
- Les portes à charnières, telles que celles sur un coffre-fort ou DAB, et autres dispositifs sans voies de transmission acoustiques continus, doivent être protégés par leurs propres détecteurs.
- Retirer les vis de fixation du couvercle et séparer le couvercle de la base, voir Figure 1(A) / 2(B).
- Percez des trous sur la surface de montage, en utilisant la base de détecteur ou la plaque de montage comme gabarit, comme suit:

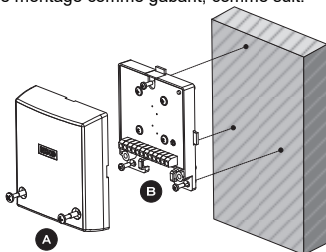

Figure 1: Montage du détecteur directement sur une surface métallique

Montage direct sur une surface métallique (Figure. 1)

- a. Assurez-vous que la surface de montage est de niveau à 0.1mm.
- b. Utiliser la base de détecteur en tant que gabarit de perçage pour les trois trous (3.2 mm dia.) et faire un filetage M4 sur 6 mm de profondeur au minimum. Ebavurez les trous métalliques filetés.
- c. Monter le détecteur à l'aide des vis de fixation fournies, voir Figure 1(B).

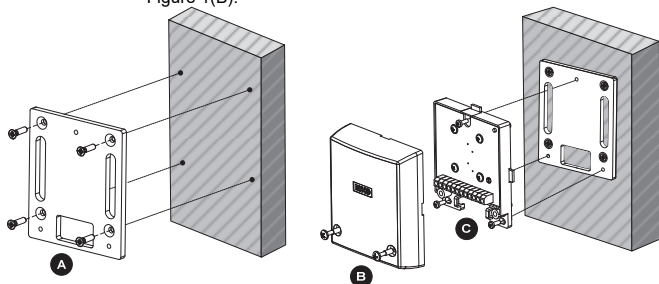

Figure 2: Montage du détecteur à l'aide de la plaque de montage. (Remarque: Fixer la plaque de montage au moyen de vis de fixation ou éventuellement, par soudage de la plaque sur une surface métallique.)

Installation à l'aide de la plaque de montage (Figure 2):

- a. (Option soudage des métaux) Souder la plaque de montage sur les deux oblongs verticaux découpés prévus. Enlever les éclaboussures de soudure de la surface de la plaque.
- b. (Sur du béton) :
Ne jamais installer le détecteur directement sur une surface de béton nu ou plâtré, car des forces de flexion peuvent endommager le capteur sismique. Le plâtre de moins de 10 mm n'a pas besoin d'être retiré.
 - i. Percez quatre trous pour la plaque de montage (diamètre 8mm, min 35 mm profondeur pour fixation; en utilisant une mèche carbure).
 - ii. Utilisez la plaque de montage comme gabarit de perçage pour les trois trous filetés de détection (5 mm de diamètre) d'au moins 3 mm de profondeur.
 - iii. Insérer les embouts métalliques fournis dans les trous percés au ras de la surface du béton
 - iv. Assurez-vous que la plaque de montage est correctement positionnée. Appliquer la plaque de montage sur la surface, frapper la vis avec embout et serrer bien. La plaque ne doit pas être capable de tourner.

- v. Monter le détecteur à l'aide des vis de fixation fournies, voir Figure 2(C).
- c. (Sur du métal) :
- i. Utilisez la plaque de montage comme gabarit de perçage pour les quatre trous (diamètre 5 mm) et enfoncez le filetage M6 d'au moins 10 mm de profondeur. Ebavurez trous métalliques filetés.
 - ii. Utilisez la plaque de montage comme gabarit de perçage pour les trois trous filetés de détection (diamètre 5 mm) d'au moins 3 mm de profondeur.
 - iii. Fixez la plaque de montage avec les vis fournies. La plaque ne doit pas être capable de tourner.
 - iv. Monter le détecteur à l'aide des vis de fixation fournies, voir Figure 2(C).
- Connecter le fils; Reportez-vous à la section Borniers.
 - Réglez les cavaliers; Reportez-vous à la section de sélection des cavaliers.
 - Réglez les commutateurs DIP; Reportez-vous à la section Paramètres commutateurs DIP.
 - Pour vérifier le fonctionnement du détecteur, effectuer:
 - c. Un autotest (Voir la section test du détecteur).
 - a. Un calibrage de la sensibilité à l'aide d'un générateur de test externe (voir la section du générateur de test externe).
 - Remplacez le couvercle et serrez les vis de fixation du couvercle; voir Figure 1(A)/2(B).

DISPOSITION BORNIER

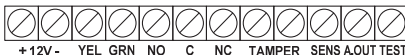



Figure 3: Disposition Bornier

Bornier	Description
+12V (RED)	Alimentation positive (+) tension d'entrée
- (BLK)	Alimentation négative (-) tension d'entrée
YEL	Utilisé pour les communications de données avec les centrales RISCO (uniquement pour la connexion BUS)
GRN	Utilisé pour les communications de données avec les centrales RISCO (uniquement pour la connexion BUS)
NO	Sortie Alarme relais normalement ouvert, 24VDC.0.1A
C	Sortie Alarme Commun relais
NC	Sortie Alarme relais normalement fermé, 24VDC.0.1A
AUTOPROTECTION	N.F. Inter. Autoprotection, 24VDC.0.1A

Bornier	Description
SENS	Contrôle de la sensibilité à distance pour diminuer la sensibilité aux vibrations pour les distributeurs de billets lors du chargement ou lorsque d'une vibration interne est générée. GND = Sensibilité Faible Non Connecté = Sensibilité normale
A.OUT	Sortie Signal analogique: Branchez un multimètre/Oscilloscope ou un testeur analogique entre le A.OUT et la borne -12V, pour visualiser le niveau de tension du signal de bruit (en parallèle à la visualisation sur le barre graphe à LED). En l'absence de vibration, la tension du signal est de 0V, et elle augmente avec la détection des vibrations. Si la tension mesurée (en l'absence de vibrations) ne reste pas stable, mais continue d'augmenter, cela signifie qu'un bruit ambiant est capté et par conséquent la sensibilité du détecteur doit être réduite.
TEST	Un court-circuit entre TEST et GND active le test à distance (voir Paramètres commutateur DIP 8 et 9). (Non significatif en mode BUS.)

AFFICHAGE LED en mode NORMAL

LED ALLUMEE	Couleur	Sévérité	Description
LD1	Rouge		Détection Alarme Température
LD2	Rouge		Alarme détection Vibration: Barre graphe (à partir de LED8-2) indiquant la puissance du signal.
LD3	Jaune		
LD4-8	Vert		
LD9	Vert		Alimenté





NOTE:

En mode test, les écrans LED ont une signification différente. Reportez-vous à la section: Test du détecteur

REGLAGES Dipswitch

MODE AUTONOME

Dip Switch	Description (SW7 OFF)																																				
SW1 SW2 SW3	<p>Permet de déterminer la sensibilité du détecteur. La sensibilité est fonction de la zone de couverture et de la surface du matériau.</p> <table border="1"> <tr> <td>SW1</td> <td>SW2</td> <td>SW3</td> <td></td> </tr> <tr> <td>*OFF</td> <td>*OFF</td> <td>*OFF</td> <td></td> </tr> <tr> <td>ON</td> <td>OFF</td> <td>OFF</td> <td></td> </tr> <tr> <td>OFF</td> <td>ON</td> <td>OFF</td> <td></td> </tr> <tr> <td>ON</td> <td>ON</td> <td>OFF</td> <td></td> </tr> <tr> <td>OFF</td> <td>OFF</td> <td>ON</td> <td></td> </tr> <tr> <td>ON</td> <td>OFF</td> <td>ON</td> <td></td> </tr> <tr> <td>OFF</td> <td>ON</td> <td>ON</td> <td></td> </tr> <tr> <td>ON</td> <td>ON</td> <td>ON</td> <td></td> </tr> </table> <p style="text-align: center;"> Faible Sensibilité  Haute Sensibilité </p>	SW1	SW2	SW3		*OFF	*OFF	*OFF		ON	OFF	OFF		OFF	ON	OFF		ON	ON	OFF		OFF	OFF	ON		ON	OFF	ON		OFF	ON	ON		ON	ON	ON	
SW1	SW2	SW3																																			
*OFF	*OFF	*OFF																																			
ON	OFF	OFF																																			
OFF	ON	OFF																																			
ON	ON	OFF																																			
OFF	OFF	ON																																			
ON	OFF	ON																																			
OFF	ON	ON																																			
ON	ON	ON																																			
SW4	<p>Utilisé pour détecter des signaux uniques et très brefs et intenses (y compris les explosions et les marteaux piqueurs).</p> <p>ON: Validé *OFF: Dévalidé</p>																																				
SW5 SW6	<p>Permet de régler le temps d'intégration. En combinaison avec SW1-3, ils établissent une valeur de seuil; SW5-6 établit une valeur de signal d'alarme cumulative qui, lors du dépassement de la valeur de seuil, déclenche un événement d'alarme.</p> <table border="1"> <tr> <th>SW5</th> <th>SW6</th> <th>Durée (en sec.)</th> </tr> <tr> <td>*OFF</td> <td>*OFF</td> <td>10 (exemple: distributeur automatique)</td> </tr> <tr> <td>ON</td> <td>OFF</td> <td>26</td> </tr> <tr> <td>OFF</td> <td>ON</td> <td>46</td> </tr> <tr> <td>ON</td> <td>ON</td> <td>80 (exemple: coffre de banque)</td> </tr> </table> <p style="text-align: center;">  Haute Sensibilité </p>	SW5	SW6	Durée (en sec.)	*OFF	*OFF	10 (exemple: distributeur automatique)	ON	OFF	26	OFF	ON	46	ON	ON	80 (exemple: coffre de banque)																					
SW5	SW6	Durée (en sec.)																																			
*OFF	*OFF	10 (exemple: distributeur automatique)																																			
ON	OFF	26																																			
OFF	ON	46																																			
ON	ON	80 (exemple: coffre de banque)																																			
SW7	<p>Utilisé pour déterminer, le mode autonome ou BUS (Assurez-vous que la position de J12 (ci-dessous) correspond à la spécification SW7.</p> <p>ON: BUS *OFF: Autonome</p>																																				
SW8	<p>Utilisé pour déterminer test local ou distant</p> <p>ON: Local. Un autotest interne est effectué toutes les 24 heures à partir de la mise sous tension. Un échec du test allume les LED's (voir la section Test de détection) et les voyants restent allumés jusqu'à l'autotest suivant.</p> <p>*OFF: Distant. Un test est activé chaque fois que l'entrée de test est connectée à GND. Si le test réussit, le relais d'alarme s'ouvre pendant trois secondes.</p>																																				

Dip Switch	Description (SW7 OFF)
SW9	Générateur de test externe ON: Valide le Générateur de test externe *OFF: Dévalidé (test interne)
SW10	Utilisé pour valider le détecteur de température (seuil de température d'alarme de 85°C) ON: Validé *OFF: Dévalidé (Pas de température. Le seuil est fixe)
SW11	Utilisé pour déterminer le fonctionnement des LED ON: Validé *OFF: Dévalidé
SW12	Non Utilisé



MODE BUS

Dip Switch	Description
SW1-5	Adresse BUS
SW7	ON: BUS
SW6,8-12	Non Applicable

ID	1	2	3	4	5
01	OFF	OFF	OFF	OFF	OFF
02	ON	OFF	OFF	OFF	OFF
03	OFF	ON	OFF	OFF	OFF
04	ON	ON	OFF	OFF	OFF
05	OFF	OFF	ON	OFF	OFF
06	ON	OFF	ON	OFF	OFF
07	OFF	ON	ON	OFF	OFF
08	ON	ON	ON	OFF	OFF
09	OFF	OFF	OFF	ON	OFF
10	ON	OFF	OFF	ON	OFF
11	OFF	ON	OFF	ON	OFF
12	ON	ON	OFF	ON	OFF
13	OFF	OFF	ON	ON	OFF
14	ON	OFF	ON	ON	OFF
15	OFF	ON	ON	ON	OFF
16	ON	ON	ON	ON	OFF

ID	1	2	3	4	5
17	OFF	OFF	OFF	OFF	ON
18	ON	OFF	OFF	OFF	ON
19	OFF	ON	OFF	OFF	ON
20	ON	ON	OFF	OFF	ON
21	OFF	OFF	ON	OFF	ON
22	ON	OFF	ON	OFF	ON
23	OFF	ON	ON	OFF	ON
24	ON	ON	ON	OFF	ON
25	OFF	OFF	OFF	ON	ON
26	ON	OFF	OFF	ON	ON
27	OFF	ON	OFF	ON	ON
28	ON	ON	OFF	ON	ON
29	OFF	OFF	ON	ON	ON
30	ON	OFF	ON	ON	ON
31	OFF	ON	ON	ON	ON
32	ON	ON	ON	ON	ON

CAVALIERS de SELECTION

Cavaliers	Fonction	
S.A (Autonome)/BUS J12	Permet d'activer l'indication de sabotage dans les modes autonome ou BUS.	
		Mode Autonome (Défaut).
		Mode connexion BUS. (Voir les manuels de programmation du système RISCO).
J13: EOL Alarme J15: EOL Autoprotection	Les cavaliers J13 et J15 permettent la sélection des résistances de fin de ligne d'alarme et sabotage (1K, 2.2K, 4.7K, 5.6K et 6.8K) en fonction de la centrale. Suivre le schéma de connexion par bornier à la figure 4 lors de la connexion d'une zone de détection avec une double résistance de fin de ligne (DEOL)..	

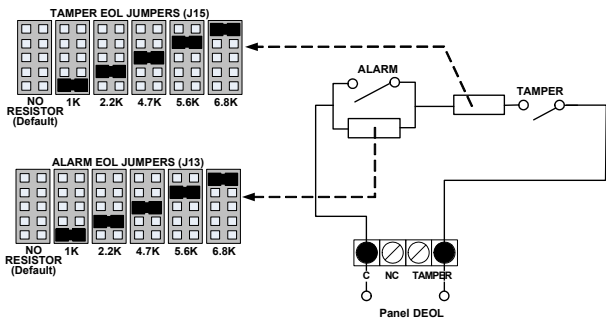

Figure 4: Schéma des Résistances de fin de ligne

TEST DU DETECTEUR

RISCO recommande d'effectuer un autotest après l'installation et avant la fermeture du capot. Le test peut être effectué manuellement (localement ou à distance) ou automatiquement toutes les 24 heures.

Autotest à distance (Test Manuel)

Ce test nécessite une commande pour être exécuté.

Pour activer l'autotest à distance:

- Assurez-vous que le commutateur DIP SW8 est réglé sur OFF.
- Relier la borne TEST à GND.
- Tous les voyants s'allument pour indiquer le début du test et s'éteignent séquentiellement après chaque test réussi.

L'autotest de l'unité de détection examine les paramètres suivants:

LED	Trouble
1	Panne d'alimentation externe
2	Tension interne défectueuse
4	Défaillance du capteur piézo-électrique
5	Défaillance du capteur de température
3, 6-9	Non Applicable

Tous les voyants s'éteignent à la fin d'un test réussi, sauf la LED POWER (LED9) et le relais d'alarme s'ouvre pendant trois secondes. En cas de dysfonctionnement, une des LED reste allumée.

Autotest Local (Test Automatique)

Assurez-vous que le commutateur DIP SW8 est réglé sur ON.

Le détecteur RK66S lance un Autotest automatique local toutes les 24 heures à partir de sa mise sous tension initiale. La Procédure de test et le résultat est similaire à l'autotest distant ci-dessus.

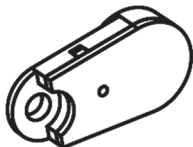

Vue de face

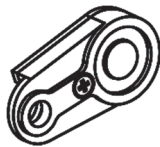

Vue arrière

Fixer le testeur à la surface en béton, à l'aide de la vis de fixation fournie dans l'ouverture prévue à cet effet.

Le générateur de test extérieur peut être utilisé pour:

- ◆ Vérifier périodiquement le bon fonctionnement du détecteur
- ◆ Observer la sensibilité du détecteur lors de l'installation

Pour utiliser le générateur de test:

- Connecter le générateur de test à J2 sur la carte du circuit imprimé (avec la polarité du fil rouge reliée à la broche de la prise la plus proche du bornier, en d'autres termes, la plus basse)
- Switch SW9 sur ON.
- Fixer le générateur de test à la surface du béton.
- Effectuer un essai, comme suit:
 - c. Pour l'essai à distance, voir la section Paramètres Dipswitch
 - a. Pour le test d'étalonnage, Switch SW8 sur ON et observer les LED

Spécifications

Couverture	Jusqu'à 5 mètres de rayon
Tension d'Alimentation	9 à 16V DC
Consommation	20mA Typique @ 12VDC
Immunité RFI	Conforme à EN50130-4
Contacts d'Alarme	24V DC, 0.1A, N/F et N/O
Contacts d'Autoprotection	24V DC, 0.1A
Temps de maintien du contact d'alarme	2.5 secondes
Température de fonctionnement	-40°C à +70°C
Température de Stockage	-50°C à +70°C
Indice de protection (IP)	IP43
Note d'impact	IK08
Dimensions (L x H x P)	102 X 27.5 X 80.2 mm
Poids	220 g

Afin de continuer à améliorer le produit, RISCO Group se réserve le droit de modifier les spécifications et / ou la conception sans préavis.

Information de commande

Modèle	Description
RK66S	Détecteur Sismique

ES

DETECTOR SÍSMICO



MODELO: RK66S
INSTRUCCIONES DE INSTALACIÓN

INTRODUCCIÓN

El Detector sísmico RISCO se utiliza para la protección contra intentos de robo de cámaras acorazadas, cajas fuertes, paredes de hormigón reforzado, y armarios y puertas acorazadas de acero. El detector sísmico controla la vibración y la temperatura de una superficie específica y reaccionará a todos los tipos conocidos de ataques de intrusos, como martillos, taladros de diamante, explosivos, herramientas de presión hidráulica y herramientas térmicas.

El detector puede funcionar tanto como un detector de relé normal conectado a cualquier central, como un accesorio de BUS cuando se conecta a las centrales de RISCO Group a través del BUS RS485, lo que le brinda capacidades únicas de diagnóstico y control remoto.

Las instrucciones que se detallan a continuación describen el detector sísmico RISCO en modo Independiente y BUS. Para la programación de la instalación del BUS, consulte los manuales de instalación de los sistemas RISCO.

Características principales:

- Sensor piezoeléctrico
- Detección de temperatura alta/baja
- Radio de detección de hasta 5 metros
- Tamper de protección
- Protección antitaladros
- Control remoto de la sensibilidad
- Salida de señal analógica
- Barra de indicadores LED
- Autotest remoto
- Conexión en modo Independiente o modo RISCO BUS

KIT DE INSTALACIÓN

Cada kit incluye:

Elementos de fijación de estructura de pared:



Tacos de expansión M6 x 16
Tornillo mecanizado de cabeza plana M6 X 16

Elementos de fijación de estructura metálica:



Arandela dentada interna M4
Tornillo mecanizado de cabeza plana M4 X 16

Generador de test externo

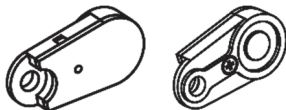

Detector

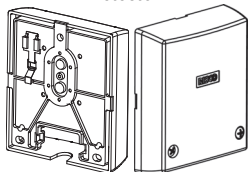

Placa de montaje

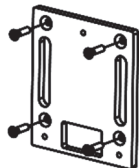

(Obligatorio para superficies como hormigón)

DESCRIPCIÓN DE LA PLACA

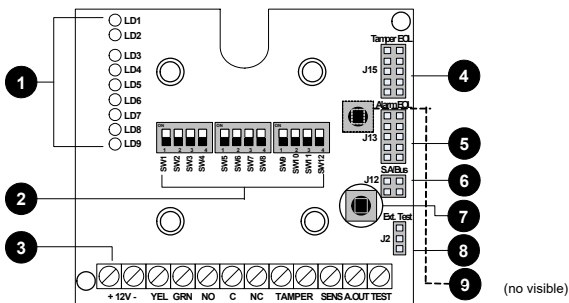

1	Barra de LED	2	Microinterruptores (por defecto)	3	Terminal de conexiones
4	Puente Tamper RFL	5	Puente Alarma RFL	6	Puente Independiente/BUS
7	Tamper frontal	8	Conector Generador de test externo	9	Tamper trasero

MONTAJE DEL DETECTOR

- Determine la posición de montaje. Deben tenerse en cuenta las posibles fuentes de falsas alarmas al instalar el RK66S, por lo tanto:
- Conecte el sensor a una superficie lo más aislada posible de vibraciones extrañas, con contacto cercano entre la superficie de hormigón y el detector. En el caso de superficies metálicas, retire la pintura residual del sitio de instalación del sensor. ¡No utilice grasa de silicona entre el sensor y el objeto!
- Para lograr la máxima detección de vibraciones, la superficie de hormigón debe ser lisa. Use la placa de montaje (consulte la Figura 2) si la instalación se realiza en superficies de acero, ladrillo u hormigón resistentes a la perforación. La placa también puede soldarse sobre superficies metálicas.
- Ajuste los microinterruptores para configurar la sensibilidad, el tiempo y otros parámetros (consulte la sección de configuración de microinterruptores a continuación) para la vibración de fondo, teniendo en cuenta la relación inversa entre el rango de detección y la sensibilidad y el material de construcción del objeto que se va a controlar. Los detectores con alta sensibilidad pueden separarse hasta 5 m en superficies seguras protegidas (por ejemplo, acero), confirmadas por pruebas de martillos o rasguños.
- Las puertas batientes, como las de cajas fuertes o cajeros automáticos, y otros accesorios sin vías de transmisión acústica continua deben protegerse con sus propios detectores.
- Retire los tornillos de fijación de la tapa para separar la tapa de la base. Consulte la Figura 1(A)/2(B).
- Perfore orificios en la superficie de montaje de la siguiente manera utilizando la base del detector o la placa de montaje como guía:



Figura 1: Montaje del detector directamente sobre una superficie metálica

Montaje directo sobre una superficie metálica (Figura 1)

- Asegúrese de que la superficie de montaje esté nivelada a 0,1 mm.
- Utilice la base del detector como plantilla de perforación para los tres orificios (3,2 mm de diámetro) e introduzca la rosca M4 al menos a 6 mm de profundidad. Desbarbe los orificios roscados en el metal.
- Ajuste el detector con los tornillos de fijación suministrados. Consulte la Figura 1(B).

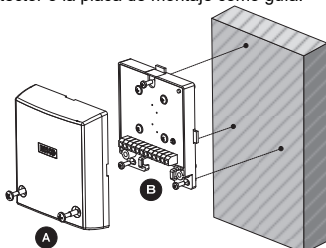

Figura 2: Montaje del detector con la placa de montaje. (Nota: Fije la placa de montaje utilizando tornillos de fijación o, si lo desea, soldando la placa a una superficie metálica.)

Instalación con placa de montaje (Figura 2):

- (Soldadura opcional) Suelde la placa de montaje a lo largo de las dos superficies de corte verticales provistas. Quite la suciedad y retire las salpicaduras de soldadura de la superficie de la placa.
- (En hormigón):
Nunca instale el detector directamente sobre una superficie de hormigón sin revestimiento o enlucida, ya que las fuerzas de flexión podrían dañar el sensor sísmico. No es necesario retirar el yeso de menos de 10 mm.
 - Taladre cuatro orificios para la placa de montaje (8 mm de diámetro, mín. 35 mm de profundidad para anclajes) con una broca de carburo sinterizado.
 - Además, use la placa de montaje como plantilla de perforación para los tres orificios roscados del detector (5 mm de diámetro) al menos con 3 mm de profundidad.
 - Inserte los tapones de metal provistos en el orificio perforado al ras con la superficie de hormigón.

- iv. Asegúrese de que la placa de montaje esté colocada correctamente. Presione la placa de montaje sobre la superficie, golpee el tornillo con el taco y apriételo bien. La placa no debe poder girar.
 - v. Ajuste el detector con los tornillos de fijación suministrados. Consulte la Figura 2(C).
 - i. (En metal):
 - i. Utilice la placa de montaje como plantilla de perforación para los cuatro orificios (5 mm de diámetro) e introduzca la rosca M6 al menos a 10 mm de profundidad. Desbarbe los orificios roscados en el metal.
 - ii. Además, use la placa de montaje como plantilla de perforación para los tres orificios roscados del detector (5 mm de diámetro) al menos con 3 mm de profundidad.
 - iii. Fije la placa de montaje con los tornillos suministrados. La placa no debe poder girar.
 - iv. Ajuste el detector con los tornillos de fijación suministrados. Consulte la Figura 2(C).
- Conecte el cableado. Consulte la sección Terminal de conexiones.
- Ajuste los puentes. Consulte la sección Selección de puentes.
- Ajuste los microinterruptores. Consulte la sección Configuración de los microinterruptores.
- Para comprobar el funcionamiento del detector:
 - d. Lleve a cabo un autotest (consulte la sección Probar el detector).
 - e. calibre la sensibilidad con un generador de test externo (consulte la sección Generador de test externo).
- Quite la tapa y vuelva a ponerla con los tornillos de fijación. Consulte la Figura 1(A)/2(B).

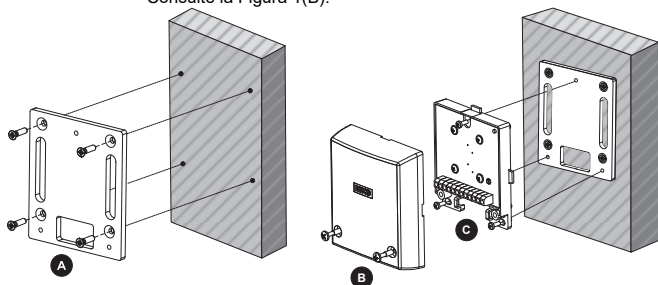
TERMINAL DE CONEXIONES



Figura 3: Terminal de conexiones

Terminal de conexiones	Descripción
+12 V (ROJO)	Entrada del positivo de la alimentación (+)
- (NEGRO)	Entrada del negativo de la alimentación (-)
Amarillo (YEL)	Utilizado para la comunicación de datos con las centrales RISCO (solo para conexión en modo BUS)
Verde (GRN)	Utilizado para la comunicación de datos con las centrales RISCO (solo para conexión en modo BUS)
NO	Salida de relé, contacto de alarma normalmente abierto, 24 V CC - 0,1 A
C	Salida de relé de alarma común
NC	Salida de relé, contacto de alarma normalmente cerrado, 24 V CC - 0,1 A
TAMPER	N.C. Interruptor Tamper , 24 V CC - 0,1 A
SENS	Control remoto de la sensibilidad (para reducir la sensibilidad de vibración en cajeros automáticos cuando se dispensa el dinero y se genera una vibración interna). GND = Sensibilidad baja Sin conectar = Sensibilidad normal
A.OUT	Salida de señal analógica: Conecte un polímetro/osciloscopio o un comprobador analógico entre los terminales A.OUT y -12V para ver la señal de ruido y el nivel de voltaje (en paralelo con la barra de indicadores LED). En ausencia de vibraciones, el voltaje es 0 V. Incrementará a medida que detecte vibraciones. Si la medida del voltaje (sin vibraciones) no permanece estable pero continúa avanzando, significa que está detectando ruido ambiental y, por lo tanto, es preciso reducir la sensibilidad del detector.
TEST	Un corto entre los terminales TEST y GND activa el test remoto (ver la configuración de los microinterruptores 8 y 9). (No se aplica en el modo BUS.)

INDICADORES LED EN MODO NORMAL

LED (encendido)	Color	Gravedad	Descripción
LD1	Rojo		Detección de alarma de temperatura
LD2	Rojo		Detección de alarma de vibración: La barra de LED (desde LED8-2) indica la potencia de la señal.
LD3	Amarillo		
LD4-8	Verde		
LD9	Verde		Dispositivo encendido





NOTA:

Durante el modo de test, los indicadores LED tienen significados distintos. Consulte la sección: Probar el detector.

CONFIGURACIÓN DE LOS MICROINTERRUPTORES

Modo Independiente

Microinterruptor	Descripción (SW7 OFF)																											
SW1 SW2 SW3	<p>Se utiliza para determinar la sensibilidad del detector. La sensibilidad es una función de la zona de cobertura y el material de la superficie.</p> <table border="1" data-bbox="326 895 533 1150"> <thead> <tr> <th>SW1</th> <th>SW2</th> <th>SW3</th> </tr> </thead> <tbody> <tr> <td>*OFF</td> <td>*OFF</td> <td>*OFF</td> </tr> <tr> <td>ON</td> <td>OFF</td> <td>OFF</td> </tr> <tr> <td>OFF</td> <td>ON</td> <td>OFF</td> </tr> <tr> <td>ON</td> <td>ON</td> <td>OFF</td> </tr> <tr> <td>OFF</td> <td>OFF</td> <td>ON</td> </tr> <tr> <td>ON</td> <td>OFF</td> <td>ON</td> </tr> <tr> <td>OFF</td> <td>ON</td> <td>ON</td> </tr> <tr> <td>ON</td> <td>ON</td> <td>ON</td> </tr> </tbody> </table> <div style="text-align: center;"> <p>Sensibilidad baja</p>  <p>Sensibilidad alta</p> </div>	SW1	SW2	SW3	*OFF	*OFF	*OFF	ON	OFF	OFF	OFF	ON	OFF	ON	ON	OFF	OFF	OFF	ON	ON	OFF	ON	OFF	ON	ON	ON	ON	ON
SW1	SW2	SW3																										
*OFF	*OFF	*OFF																										
ON	OFF	OFF																										
OFF	ON	OFF																										
ON	ON	OFF																										
OFF	OFF	ON																										
ON	OFF	ON																										
OFF	ON	ON																										
ON	ON	ON																										
SW4	<p>Se utiliza para detectar señales extremadamente breves, cortas y muy intensas (incluidas explosiones y golpes de martillos).</p> <p>ON: Habilitado *OFF: Deshabilitado</p>																											

Microinterruptor	Descripción (SW7 OFF)															
SW5 SW6	<p>Se utiliza para ajustar el tiempo de integración. En combinación con SW1-3 establecen un valor de umbral; SW5-6 establece un valor de señal de alarma acumulativa y, cuando se supera el valor del umbral, se activa un evento de alarma.</p> <table border="1"> <thead> <tr> <th>SW5</th> <th>SW6</th> <th>Duración (en segundos)</th> </tr> </thead> <tbody> <tr> <td>*OFF</td> <td>*OFF</td> <td>10 (ejemplo: máquinas expendedoras)</td> </tr> <tr> <td>ON</td> <td>OFF</td> <td>26</td> </tr> <tr> <td>OFF</td> <td>ON</td> <td>46</td> </tr> <tr> <td>ON</td> <td>ON</td> <td>80 (ejemplo: cámaras acorazadas de bancos)</td> </tr> </tbody> </table> <p style="text-align: right;">Sensibilidad baja</p>  <p style="text-align: right;">Sensibilidad alta</p>	SW5	SW6	Duración (en segundos)	*OFF	*OFF	10 (ejemplo: máquinas expendedoras)	ON	OFF	26	OFF	ON	46	ON	ON	80 (ejemplo: cámaras acorazadas de bancos)
SW5	SW6	Duración (en segundos)														
*OFF	*OFF	10 (ejemplo: máquinas expendedoras)														
ON	OFF	26														
OFF	ON	46														
ON	ON	80 (ejemplo: cámaras acorazadas de bancos)														
SW7	<p>Se utiliza para determinar el modo Independiente o BUS (asegúrese de que la posición del puente <i>J12</i> (como puede ver más abajo) coincide con la configuración del microinterruptor SW7)</p> <p>ON: BUS *OFF: Independiente</p>															
SW8	<p>Se utiliza para determinar el test local o remoto</p> <p>ON: Local. Cada 24 horas desde el encendido del detector, se realiza un autotest interno. Un fallo en el test encenderá los indicadores LED (consulte la sección <i>Probar el detector</i>) y los LED permanecen encendidos hasta el siguiente autotest.</p> <p>*OFF: Remoto. El test del detector se activa cuando el terminal TEST se conecta a GND. Si el detector pasa el test, el relé de alarma se abre durante tres segundos.</p>															
SW9	<p>Generador de test externo</p> <p>ON: Habilita el Generador de test externo *OFF: Deshabilitado (test interno)</p>															
SW10	<p>Se utiliza para habilitar el sensor de temperatura (umbral de alarma de temperatura +85 °C (+185 °F))</p> <p>ON: Habilitado *OFF: Deshabilitado (No se define ningún umbral de temperatura)</p>															
SW11	<p>Determina el funcionamiento de los indicadores LED</p> <p>ON: Habilitado *OFF: Deshabilitado</p>															
SW12	No se usa															



MODO BUS

Microinterruptor	Descripción
SW1-5	Dirección BUS
SW7	ON: BUS
SW6,8-12	No se aplica

ID	1	2	3	4	5
01	OFF	OFF	OFF	OFF	OFF
02	ON	OFF	OFF	OFF	OFF
03	OFF	ON	OFF	OFF	OFF
04	ON	ON	OFF	OFF	OFF
05	OFF	OFF	ON	OFF	OFF
06	ON	OFF	ON	OFF	OFF
07	OFF	ON	ON	OFF	OFF
08	ON	ON	ON	OFF	OFF
09	OFF	OFF	OFF	ON	OFF
10	ON	OFF	OFF	ON	OFF
11	OFF	ON	OFF	ON	OFF
12	ON	ON	OFF	ON	OFF
13	OFF	OFF	ON	ON	OFF
14	ON	OFF	ON	ON	OFF
15	OFF	ON	ON	ON	OFF
16	ON	ON	ON	ON	OFF

ID	1	2	3	4	5
17	OFF	OFF	OFF	OFF	ON
18	ON	OFF	OFF	OFF	ON
19	OFF	ON	OFF	OFF	ON
20	ON	ON	OFF	OFF	ON
21	OFF	OFF	ON	OFF	ON
22	ON	OFF	ON	OFF	ON
23	OFF	ON	ON	OFF	ON
24	ON	ON	ON	OFF	ON
25	OFF	OFF	OFF	ON	ON
26	ON	OFF	OFF	ON	ON
27	OFF	ON	OFF	ON	ON
28	ON	ON	OFF	ON	ON
29	OFF	OFF	ON	ON	ON
30	ON	OFF	ON	ON	ON
31	OFF	ON	ON	ON	ON
32	ON	ON	ON	ON	ON

SELECCIÓN DE LOS PUENTES

Puente	Función
S.A (Independiente)/BUS J12	Se utiliza para habilitar la indicación de tamper en modo Independiente o BUS.
	 Modo Independiente (por defecto).
	 Conexión en modo BUS. (Consulte los manuales de programación de los sistemas RISCO).
J13: Alarma RFL J15: Tamper RFL	Los puentes J13 y J15 permiten seleccionar el valor de la resistencia de Alarma y Tamper (1K, 2.2K, 4.7K, 5.6K y 6.8K) según la central utilizada. Siga el esquema de conexiones de la Figura 4 cuando vaya a conectar el detector como zona con doble resistencia de fin de línea (DRFL).



Figura 4: Esquema de resistencias de fin de línea

PROBAR EL DETECTOR

RISCO recomienda llevar a cabo un autotest después de instalar el detector y antes de montar la tapa. El test se puede realizar manualmente (en local o de forma remota), o automáticamente cada 24 horas.

Autotest remoto (manual)

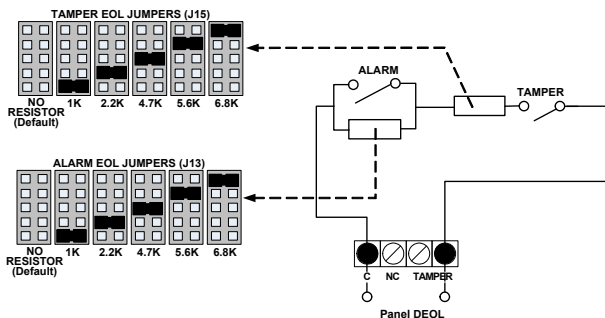
Este test necesita un comando de activación para llevarse a cabo.

Para activar el autotest remoto:

- Asegúrese de que el microinterruptor SW8 está en la posición OFF.
- Cortocircuite con un puente los terminales TEST y GND.
- Todos los indicadores LED se encenderán para indicar el comienzo del test y se irán apagando secuencialmente cuando se haya verificado correctamente cada parámetro.

El autotest del detector comprueba los siguientes parámetros:

LED	Problema
1	Fallo de alimentación externo
2	Fallo de voltaje interno
4	Fallo del sensor piezoeléctrico
5	Fallo del sensor de temperatura
3, 6-9	No se aplica

Todos los indicadores LED se apagarán cuando finalice correctamente un test, excepto el LED de alimentación (LED9), y el relé de alarma se abrirá durante tres segundos. Si se produce un fallo, uno de los LED permanece encendido.

Autotest local (automático)

Asegúrese de que el microinterruptor SW8 está en la posición ON.

El detector RK66S activará un AUTOTEST local/automático cada 24 horas desde su encendido inicial. El procedimiento para realizar el test y la comprobación del resultado es igual que para el autotest remoto, explicado anteriormente.

Generador de test Externo

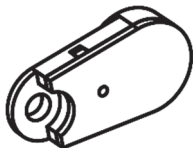

Vista frontal

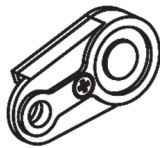

Vista trasera

Fije a la superficie de hormigón con el tornillo de montaje suministrado en esta abertura del orificio.

El generador de test externo se puede usar para:

- ♦ Verificar periódicamente el correcto funcionamiento del detector
- ♦ Observar la sensibilidad del detector durante la instalación

Para utilizar el generador de test:

- Conecte el generador de test al terminal J2 en la placa base (con la polaridad resultante del cable rojo conectado a la patilla más cercana al terminal de conexiones, es decir, la situada más abajo)
- Ponga el interruptor SW9 en la posición ON.
- Fije el generador de test a la superficie de hormigón.
- Lleve a cabo un test del modo siguiente:
 - d. Para un test remoto, consulte la sección Configuración de los microinterruptores
 - e. Para un test de calibración, ponga el interruptor SW8 en la posición ON. y observe los indicadores LED

Especificaciones

Cobertura	Hasta un radio de 5 metros
Voltaje de funcionamiento	De 9 a 16 V CC
Consumo de corriente	20 mA a 12 V CC
Inmunidad RFI	Conforme a la normativa EN50130-4
Contactos de alarma	24 V CC, 0,1 A, N/C y N/O
Contactos del tamper	24 V CC, 0,1 A
Tiempo de contacto de alarma	2,5 segundos
Temperatura de funcionamiento	De -40 °C a +70 °C
Temperatura de almacenaje	De -50 °C a +70 °C
Grado de protección IP	IP43
Grado de protección contra impactos	IK08
Inmunidad RFI	Conforme a la normativa EN50130-4
Dimensiones (An x Al x Pr)	102 x 27,5 x 80,2 mm
Peso	220 g

Para poder seguir mejorando el producto, RISCO Group se reserva el derecho a modificar las especificaciones y los diseños sin previo aviso.

Información para pedidos

Modelo	Descripción
RK66S	Detector sísmico

NOTAS

CN

SEISMIC 震动探测器



型号：RK66S
安装说明书

简介：

瑞斯可集团的Seismic震动探测器适用于金库、保险箱、钢筋混凝土墙壁、钢铁铠装柜和门的防护。Seismic探测器可检测到防护面的震动和温度，检测所有已知类型的攻击方式，如重锤、钻孔、爆炸、液压工具和热力工具等。

探测器既可以通过常规继电器模式安装，连接到任何的报警主机，也可以通过RS485总线方式连接到RISCO防盗报警系统，实现独特的远程参数设置及诊断功能。

此说明书描述了瑞斯可Seismic震动探测器可继电器或总线模式安装。关于总线安装编程，请参阅瑞斯可防盗报警系统安装手册。

主要特点：

- 压电传感器
- 低/高温度检测
- 探测范围可达5米的工作半径
- 防拆开关保护
- 抗钻防护外壳
- 远程调整灵敏度
- 模拟信号输出
- 条形指示灯显示
- 远程自检
- 继电器或总线模式安装

安装套件

：每个套装包含

：墙体结构固定套件



膨胀螺丝M6*16
平头螺丝 M6*16

：金属结构固定套件



内齿垫圈M4
平头螺丝M4*10

外部测试器

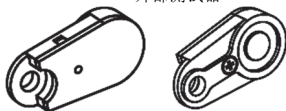

探测器

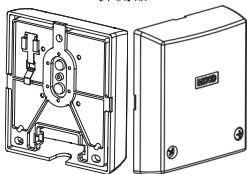

安装底板

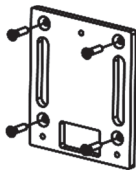

(适用于混凝土表面)

电路板图示

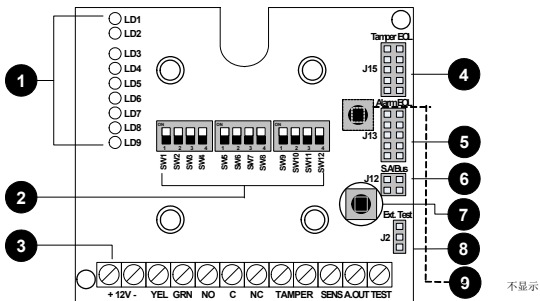

1	条形指示灯	2	拨码开关（默认状态）	3	接线端
4	防拆电阻跳线	5	报警电阻跳线	6	继电器/总线模式跳线
7	防拆（前盖）	8	外部测试器连接端	9	防拆（背部）

安装探测器

1. 确定探测器的安装位置，在安装RK66S时排除潜在的误报源，因此：

- 将探测器安装在尽可能远离外部震动源的位置，在混凝土表面和探测器之间要充分接触。去除金属表面的油污，避免在探测器和物体之间存在。硅脂润滑剂
- 为了最多范围的检测震动，混凝土表面需光滑。当安装在耐钻钢、砖墙混凝土墙上时，需使用安装底板（见图、2）。底板也可以焊接在金属表面。（
- 调整拨码开关设置灵敏度、时间和其他参数（查看拨码开关设置，如下）来探测物体的震动 -
探测范围、灵敏度和物体材料结构是成反比的。通过敲击或刮擦测试，探测器防护半径最大可达5.米范围（如：钢铁）
- 、保险箱ATM，上的铰链门、或其它无连续传输声波通道的附件。需要在其上面单独安装探测器提供保护

2. 拆除前盖固定螺丝并将其和底板分离，如图1(A) / 2(B)。

3. 使用探测器底部或安装底板选择钻孔位置，在安装表面钻孔，如下：



图1：安装探测器在金属表面

直接安装在金属表面(如图. 1)

- a. 确保安装表面在1/128” 水平之内(0.1mm)。
- b. 使用探测器背部作孔位模板钻三个孔（半径 3.2 mm.）将M4号螺丝轻敲至少 ¼”（6 mm）深。去除螺丝孔里的毛刺
- c. 使用配送的固定螺丝将探测器固定，如图1(B)。

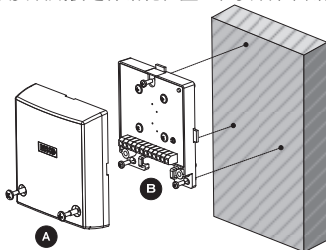

图 2: 使用安装底板固定探测器

(注意: 使用附送的固定螺丝将安装底板固定, 或通过焊接将底板固定在金属表面。)

使用配送底板安装(如图 2):

1) (可选择金属焊接)

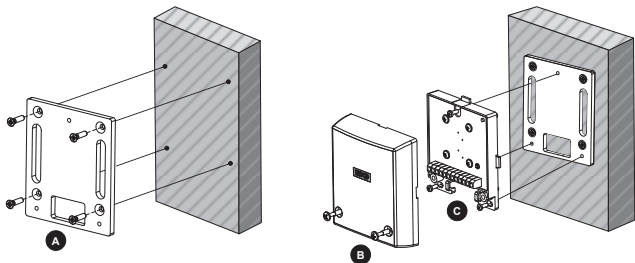
沿着长方形安装底板的2

个垂直切口面, 将安装底板焊接到金属物体表面。去除底板表面上飞溅的焊渣

2) (混凝土材料安装):

(1) 不要将探测器直接安装在裸露的混凝土上, 因为不平的表面受力可能损坏Seismic探测器。表面至少有10mm。厚度的石灰

i. 钻4个孔(半径8 mm)深度至少, 35 mm)。固定安装底板,

ii. 同样, 使用安装底板作为孔位模板, 钻3个至少3 mm深的孔(半径5 mm固定探测器(

iii. 将附带的金属螺栓, 插入混凝土表面的钻孔里

iv. 确定安装底板的正确安装位置。将安装底板按压到墙体表面, 轻敲螺丝将安装底板固定锁紧。安装底板不能旋转

v. 使用附带的固定螺丝安装探测器, 如图 2(C)。

3) (金属材质安装):

vi. 使用安装底板选择钻孔位置, 钻四个孔位(半径5 mm)

选择M6号螺丝轻敲至少10mm

。深。去除螺丝孔里的毛刺

vii. 同样,

使用安装底板选择需要的钻孔位置并钻三个孔, 深度至少3 mm(半径5 mm)。

- viii. 使用配送的固定螺丝将安装底板固定。安装底板。不能旋转
 - ix. 使用配送的固定螺丝将探测器固定, 如图 2(C)。
- 4) 4. 接线; 。参考接线端章节
 - 5) 5. 设置跳线; 。参考跳线选择章节
 - 6) 6. 拨码开关设置; 。参考拨码开关设置章节
 - 7) 7. 校验探测器操作, 执行如下步骤:
 - i. 自检测试 (参考探测器测试章节)。
 - ii. 使用外部测试器进行灵敏度校准 (参考外部测试器章节)。
 - 8) 将前盖装回并锁紧前盖固定螺丝; 如图1(A) / 2(B)。

接线端口



+12V- YEL GRN NO C NC TAMPER SENS A.OUT TEST

接线端口

接线端	说明
+12V (红)	电源 (+) 输入端
- (黑)	电源 (-) 输入端
YEL	用于连接RISCO 总线型主机的BUS端口(只适用于总线连接)
GRN	用于连接RISCO 总线型主机的BUS端口(只适用于总线连接)
NO	报警输出, 继电器常开端, 24VDC. 0. 1A
C	报警输出, 继电器公共端
NC	报警输出, 继电器常闭端 24VDC. 0. 1A
TAMPER	防拆端口, , 常闭24VDC. 0. 1A
SENS	远程灵敏度控制端口(作为探测低震动灵敏度, 如ATM机在取现过程中产生的震动) 当选择低震动时, 此端口连接到GND否则连接到. 16VDC或NC。 GND=低灵敏度 未连接= Reguler灵敏度
A. OUT	模拟信号输出端: 使用万用表连接A. OUT 和-12V两端, 查看信噪和信号电压强度(条形指示灯显示) 在震动情况下, 电压值为. 0V, 并随着震动而增加。如果测量的电压值没有保持稳定(在震动情况下), 而且会继续增加, 这代表环境信噪强度高, 应降低探测器灵敏度。
TEST	短接TEST和GND接线端, 启动远程测试功能(参考拨码开关设置8和9)。 (不适用于总线模式)

指示灯功能显示

LED灯开启	颜色	灵敏度	功能描述
LD1	红	高  低	温度感应探测报警
LD2	红		震动报警探测：条形指示灯 (LD8-2) 显示震动信号强度
LD3	黄		
LD4-8	绿		
LD9	绿		电源开启





注意：

在测试模式下，各LED指示灯的显示定义不同，详情参考：探测器测试模式。

拨码开关设置

继电器模式

拨码开关	备注(SW7 OFF)																											
SW1 SW2 SW3	用于设置探测器的灵敏度。灵敏度设置与探测范围、物体表面材料有关。 <table border="1" data-bbox="264 851 461 1113"> <thead> <tr> <th>SW1</th> <th>SW2</th> <th>SW3</th> </tr> </thead> <tbody> <tr> <td>*OFF</td> <td>*OFF</td> <td>*OFF</td> </tr> <tr> <td>ON</td> <td>OFF</td> <td>OFF</td> </tr> <tr> <td>OFF</td> <td>ON</td> <td>OFF</td> </tr> <tr> <td>ON</td> <td>ON</td> <td>OFF</td> </tr> <tr> <td>OFF</td> <td>OFF</td> <td>ON</td> </tr> <tr> <td>ON</td> <td>OFF</td> <td>ON</td> </tr> <tr> <td>OFF</td> <td>ON</td> <td>ON</td> </tr> <tr> <td>ON</td> <td>ON</td> <td>ON</td> </tr> </tbody> </table> 低灵敏度  高灵敏度	SW1	SW2	SW3	*OFF	*OFF	*OFF	ON	OFF	OFF	OFF	ON	OFF	ON	ON	OFF	OFF	OFF	ON	ON	OFF	ON	OFF	ON	ON	ON	ON	ON
SW1	SW2	SW3																										
*OFF	*OFF	*OFF																										
ON	OFF	OFF																										
OFF	ON	OFF																										
ON	ON	OFF																										
OFF	OFF	ON																										
ON	OFF	ON																										
OFF	ON	ON																										
ON	ON	ON																										
SW4	。用于测试普通信号和极端信号（包含爆炸和铁锤等） ON：开启 *OFF：关闭																											

拨码开关	备注SW7 OFF)															
SW5 SW6	<p>用于调整累计时间，结合SW1-3，两者结合建立一个阈值，SW5-6，建立累计的报警信号值，当超过阈值。会触发报警事件</p> <table border="1" style="margin-left: 20px;"> <thead> <tr> <th>SW5</th> <th>SW6</th> <th>持续时间（秒）</th> </tr> </thead> <tbody> <tr> <td>*OFF</td> <td>*OFF</td> <td>10（例如：自动售卖机）</td> </tr> <tr> <td>ON</td> <td>OFF</td> <td>26</td> </tr> <tr> <td>OFF</td> <td>ON</td> <td>46</td> </tr> <tr> <td>ON</td> <td>ON</td> <td>80（例如：银行保险库）</td> </tr> </tbody> </table> <div style="text-align: right; margin-top: 10px;"> 低灵敏度  高灵敏度 </div>	SW5	SW6	持续时间（秒）	*OFF	*OFF	10（例如：自动售卖机）	ON	OFF	26	OFF	ON	46	ON	ON	80（例如：银行保险库）
SW5	SW6	持续时间（秒）														
*OFF	*OFF	10（例如：自动售卖机）														
ON	OFF	26														
OFF	ON	46														
ON	ON	80（例如：银行保险库）														
SW7	<p>用于设置继电器或总线模式功能（确认J2（的位置，如下 ON: 总线模式 *OFF: 继电器模式</p>															
SW8	<p>用于开启本地和远程测试功能 ON: 本地。在电源开启后每24小时内内部自检一次，测试失败LED。会常亮直到下一个自检开始（见探测器自检章节） *OFF: 远程测试。短接TEST和GND接线端，激活测试功能。如果测试通过，报警继电器会打开3.秒钟</p>															
SW9	<p>外部测试仪（参看13（页 ON: 开启外部测试仪 *OFF: 关闭（内部测试）</p>															
SW10	<p>用于开启温度传感器功能（温度报警阈值+85（度以上 ON: 开启 *OFF: 关闭（未设置温度报警阈值）</p>															
SW11	<p>用于开启LED灯 ON: 开启 *OFF: 关闭</p>															
SW12	不使用															

*为出厂默认

总线模式

拨码开关	备注
SW1-5	总线地址
SW7	ON: 总线模式
SW6,8-12	Not Applicable

ID	1	2	3	4	5
01	OFF	OFF	OFF	OFF	OFF
02	ON	OFF	OFF	OFF	OFF
03	OFF	ON	OFF	OFF	OFF
04	ON	ON	OFF	OFF	OFF
05	OFF	OFF	ON	OFF	OFF
06	ON	OFF	ON	OFF	OFF
07	OFF	ON	ON	OFF	OFF
08	ON	ON	ON	OFF	OFF
09	OFF	OFF	OFF	ON	OFF
10	ON	OFF	OFF	ON	OFF
11	OFF	ON	OFF	ON	OFF
12	ON	ON	OFF	ON	OFF
13	OFF	OFF	ON	ON	OFF
14	ON	OFF	ON	ON	OFF
15	OFF	ON	ON	ON	OFF
16	ON	ON	ON	ON	OFF

ID	1	2	3	4	5
17	OFF	OFF	OFF	OFF	ON
18	ON	OFF	OFF	OFF	ON
19	OFF	ON	OFF	OFF	ON
20	ON	ON	OFF	OFF	ON
21	OFF	OFF	ON	OFF	ON
22	ON	OFF	ON	OFF	ON
23	OFF	ON	ON	OFF	ON
24	ON	ON	ON	OFF	ON
25	OFF	OFF	OFF	ON	ON
26	ON	OFF	OFF	ON	ON
27	OFF	ON	OFF	ON	ON
28	ON	ON	OFF	ON	ON
29	OFF	OFF	ON	ON	ON
30	ON	OFF	ON	ON	ON
31	OFF	ON	ON	ON	ON
32	ON	ON	ON	ON	ON

跳线选择

跳线	功能
继电器/总线模式 J12	用于在继电器或总线模式下开启防拆显示
	 继电器模式（默认）
	 总线模式（详情参考RISCO （总线系统编程手册）
J13: 报警内置终端电阻 J15: 防拆内置终端电阻	跳线J13和J15 允许根据主机的要求选择防拆和报警的终端电阻（1K, 2.2K, 4.7K, 5.6K 和 6.8K） 当使用双终端电阻。（DEOL） 功能连接探测器到主机时，请参考图4 。的终端电阻接线方式



图4: EOL终端电阻的接线方法和跳线选择

探测器测试

瑞思可建议在安装探测器后，执行自检测试功能。测试能够通过手动模式（本地或远程）或者每24.小时自动测试模式

远程自检（手动模式）

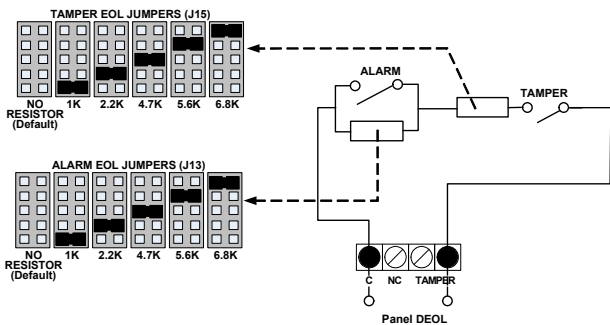
。此测试模式需要发给一个信号，开启远程自检功能

- 1. 确认拨码开关SW8到OFF。
- 2. 短接TEST和GND.的接线端
- 3. 。所有指示灯将会亮起表示测试开始，每个参数测试成功后依次关闭

LED	故障描述
1	外部供应电源故障
2	内部电压故障
4	震动传感器故障
5	温度传感器故障
3, 6-9	未使用

除了电源指示灯(LED9)所有指示灯在测试成功后关闭，并且报警继电器开路，3秒。如果有故障发生，相应的LED.灯将会开启

本地自检 (自动模式)

确定拨码开关SW8为ON。

RK66S探测器在设备加电后每24

小时运行本地或自动测试功能。测试过程和显示结果，参见上面远程自检功能

。

外部测试器

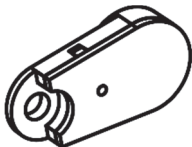

前视图

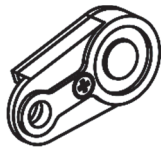

后视图

使用附带的安装螺丝，。将外部测试器从此孔固定到混凝土表面

：外部测试器用于

- ◆ 定期检查探测器的工作情况
- ◆ 在安装后观察探测器的灵敏度

：使用测试器

1. 连接测试器到电路板的J2

。端（带有极性的红色线，连接到靠近接线端的插针，黑色线连接另一端）

2. 设置拨码开关SW9为ON。

3. 将外部测试器安装到混凝土表面

4. 执行测试操作，如下

- a. 执行远程测试，查看拨码开关设置章节
- b. 执行本地测试，设置拨码开关SW8为ON观察，LED。指示灯

技术规格

探测范围	半径可达5米
工作电压	9-16VDC
电流消耗	典型 20mA @ 12VDC
报警输出	24VDC, 0.1A, 常闭/常开
防拆输出	24VDC, 0.1A
报警持续时间	2.5秒
工作温度	-400C - +700C
储存温度	-500C - +700C
外壳防护等级	IP43
冲击等级	IK08
RFI射频干扰	符合EN50130-4标准
尺寸 (长X高X宽)	102 X 27.5 X 80.2mm
重量	220g

订购信息

型号	描述
RK66S	Seismic 震动探测器

EMC Compliance Statement:

Hereby, RISCO Group declares that this equipment is in compliance with the essential requirements and other relevant provisions of Directive 2014/30/EU.

For the CE Declaration of Conformity please refer to our website: www.riscogroup.com.

Dichiarazione di Conformità EMC:

La sottoscritta RISCO Group, dichiara sotto la propria responsabilità che questo prodotto è conforme ai requisiti essenziali e alle altre rilevanti disposizioni della Direttiva Europea 2014/30/EU.

Per le Dichiarazioni di Conformità CE, visitate il nostro sito web: www.riscogroup.com

Déclaration de Conformité de EMC:

Par la présente, RISCO Group, déclare cet équipement est en conformité aux conditions essentielles et à d'autres dispositions appropriées de la directive 2014/30/EU.

Vous pouvez trouver la copie complète de la déclaration de conformité à la directive 2014/30/EU sur notre site web, à l'adresse suivante : www.riscogroup.com

Declaración de Conformidad EMC :

Por la presente, RISCO Group declara que este equipo cumple con los requisitos esenciales y otras disposiciones relevantes de la Directiva 2014/30/EU. Para la Declaración de Conformidad CE, por favor diríjase a nuestra web: www.riscogroup.com

Standard Limited Product Warranty

RISCO Ltd., its subsidiaries and affiliates ("**Risco**") guarantee Risco's hardware products to be free from defects in materials and workmanship when used and stored under normal conditions and in accordance with the instructions for use supplied by Risco, for a period of (i) 24 months from the date of connection to the Risco Cloud (for cloud connected products) or (ii) 24 months from production (for other products which are non-cloud connected), as the case may be (each, the "**Product Warranty Period**" respectively).

Contact with customers only. This Product Warranty is solely for the benefit of the customer who purchased the product directly from Risco, or from any authorized distributor of Risco. Nothing in this Warranty obligates Risco to accept product returns directly from end users that purchased the products for their own use from Risco's customer or from any installer of Risco, or otherwise provide warranty or other services to any such end user. Risco customer shall handle all interactions with its end users in connection with the Warranty, inter alia regarding the Warranty. Risco's customer shall make no warranties, representations, guarantees or statements to its customers or other third parties that suggest that Risco has any warranty or service obligation to, or any contractual privity with, any recipient of a product.

Return Material Authorization. In the event that a material defect in a product shall be discovered and reported during the Product Warranty Period, Risco shall, at its option, and at customer's expense, either: (i) accept return of the defective Product and repair or have repaired the defective Product, or (ii) accept return of the defective Product and provide a replacement product to the customer. The customer must obtain a Return Material Authorization ("**RMA**") number from Risco prior to returning any Product to Risco. The returned product must be accompanied with a detailed description of the defect discovered ("**Defect Description**") and must otherwise follow Risco's then-current RMA procedure in connection with any such return. If Risco determines in its reasonable discretion that any Product returned by customer conforms to the applicable warranty ("**Non-Defective Products**"), Risco will notify the customer of such determination and will return the applicable Product to customer at customer's expense. In addition, Risco may propose and assess customer a charge for testing and examination of Non-Defective Products.

Entire Liability. The repair or replacement of products in accordance with this warranty shall be Risco's entire liability and customer's sole and exclusive remedy in case a material defect in a product shall be discovered and reported as required herein. Risco's obligation and the Warranty are contingent upon the full payment by customer for such Product and upon a proven weekly testing and examination of the product functionality.

Limitations. The Product Warranty is the only warranty made by Risco with respect to the Products. The warranty is not transferable to any third party. To the maximum extent permitted by applicable law, the Product Warranty does not apply and will be void if: (i) the conditions set forth above are not met (including, but not limited to, full payment by customer for the product and a proven weekly testing and examination of the product functionality); (ii) if the Products or any part or component thereof: (a) have been subjected to improper operation or installation; (b) have been subject to neglect, abuse, willful damage, abnormal working conditions, failure to follow Risco's instructions (whether oral or in writing); (c) have been misused, altered, modified or repaired without Risco's written approval or combined with, or installed on products, or equipment of the customer or of any third party; (d) have been damaged by any factor beyond Risco's reasonable control such as, but not limited to, power failure, electric power surges, or unsuitable third party components and the interaction of software therewith or (e) any delay or other failure in performance of the product attributable to any means of communications, provided by any third party service provider (including, but not limited to) GSM interruptions, lack of or internet outage and/or telephony failure.

BATTERIES ARE EXPLICITLY EXCLUDED FROM THE WARRANTY AND RISCO SHALL NOT BE HELD RESPONSIBLE OR LIABLE IN RELATION THERETO, AND THE ONLY WARRANTY APPLICABLE THERETO, IF ANY, IS THE BATTERY MANUFACTURER'S WARRANTY.

Risco makes no other warranty, expressed or implied, and makes no warranty of merchantability or of fitness for any particular purpose. For the sake of good order and avoidance of any doubt:

DISCLAIMER. EXCEPT FOR THE WARRANTIES SET FORTH HEREIN, RISCO AND ITS LICENSORS HEREBY DISCLAIM ALL EXPRESS, IMPLIED OR STATUTORY, REPRESENTATIONS, WARRANTIES, GUARANTEES, AND CONDITIONS WITH REGARD TO THE PRODUCTS, INCLUDING BUT NOT LIMITED TO ANY REPRESENTATIONS, WARRANTIES, GUARANTEES, AND CONDITIONS OF MERCHANTABILITY, FITNESS FOR A PARTICULAR PURPOSE, TITLE AND LOSS OF DATA. WITHOUT LIMITING THE GENERALITY OF THE FOREGOING, RISCO AND ITS LICENSORS DO NOT REPRESENT OR WARRANT THAT: (i) THE OPERATION OR USE OF THE PRODUCT WILL BE TIMELY, SECURE, UNINTERRUPTED OR ERROR-FREE; (ii) THAT ANY FILES, CONTENT OR INFORMATION OF ANY KIND THAT MAY BE ACCESSED THROUGH THE PRODUCT BY CUSTOMER OR END USER SHALL REMAIN SECURED OR NON DAMAGED. CUSTOMER ACKNOWLEDGES THAT NEITHER RISCO NOR ITS LICENSORS CONTROL THE TRANSFER OF DATA OVER COMMUNICATIONS FACILITIES, INCLUDING THE INTERNET, GSM OR OTHER MEANS OF COMMUNICATIONS AND THAT RISCO'S PRODUCTS, MAY BE SUBJECT TO LIMITATIONS, DELAYS, AND OTHER PROBLEMS INHERENT IN THE USE OF SUCH MEANS OF COMMUNICATIONS. RISCO IS NOT RESPONSIBLE FOR ANY DELAYS, DELIVERY FAILURES, OR OTHER DAMAGE RESULTING FROM SUCH PROBLEMS. RISCO WARRANTS THAT ITS PRODUCTS DO NOT, TO THE BEST OF ITS KNOWLEDGE, INFRINGE UPON ANY PATENT, COPYRIGHT, TRADEMARK, TRADE SECRET OR OTHER INTELLECTUAL PROPERTY RIGHT

IN ANY EVENT RISCO SHALL NOT BE LIABLE FOR ANY AMOUNTS REPRESENTING LOST REVENUES OR PROFITS, PUNITIVE DAMAGES, OR FOR ANY OTHER INDIRECT, SPECIAL, INCIDENTAL, OR CONSEQUENTIAL DAMAGES, EVEN IF THEY WERE FORESEEABLE OR RISCO HAS BEEN INFORMED OF THEIR POTENTIAL.

Risco does not install or integrate the product in the end user security system and is therefore not responsible for and cannot guarantee the performance of the end user security system which uses the product. Risco does not guarantee that the product will prevent any personal injury or property loss by burglary, robbery, fire or otherwise; or that the product will in all cases provide adequate warning or protection. Customer understands that a correctly installed and maintained alarm may only reduce the risk of burglary, robbery or fire without warning, but is not an assurance or a guarantee that such an event will not occur or that there will be no personal injury or property loss as a result thereof. Consequently Risco shall have no liability for any personal injury, property damage or loss based on a claim that the product fails to give warning. No employee or representative of Risco is authorized to change this warranty in any way or grant any other warranty.

Contacting RISCO Group

RISCO Group is committed to customer service and product support. You can contact us through our website (www.riscogroup.com) or at the following telephone and fax numbers:

United Kingdom

Tel: +44-(0)-161-655-5500
support-uk@riscogroup.com

Italy

Tel: +39-02-66590054
support-it@riscogroup.com

Spain

Tel: +34-91-490-2133
support-es@riscogroup.com

USA

Tel: +1-631-719-4400
support-usa@riscogroup.com

France

Tel: +33-164-73-28-50
support-fr@riscogroup.com

Israel

Tel: +972-3-963-7777
support@riscogroup.com

China (Shanghai)

Tel: +86-21-52-39-0066
support-cn@riscogroup.com



(NOTE: Only RK66S000000A is certified with INCERT)

All rights reserved.

No part of this document may be reproduced in any form without prior written permission from the publisher.